

GigaDevice Semiconductor Inc.

GD32F407xx

ARM[®] Cortex[®]-M4 32-bit MCU

Datasheet

Table of Contents

List of Figures	3
List of Tables	4
1 Introduction	6
2 Device overview	7
2.1 Device information.....	7
2.2 Block diagram.....	9
2.3 Pinouts and pin assignment.....	10
2.4 Memory map.....	15
2.5 Clock tree.....	18
2.6 Pin definitions.....	19
3 Functional description	40
3.1 ARM® Cortex®-M4 core.....	40
3.2 On-chip memory.....	40
3.3 Clock, reset and supply management.....	41
3.4 Boot modes.....	42
3.5 Power saving modes.....	42
3.6 Analog to digital converter (ADC).....	43
3.7 Digital to analog converter (DAC).....	43
3.8 DMA.....	44
3.9 General-purpose inputs/outputs (GPIOs).....	44
3.10 Timers and PWM generation.....	45
3.11 Real time clock (RTC) and backup registers.....	46
3.12 Inter-integrated circuit (I2C).....	46
3.13 Serial peripheral interface (SPI).....	47
3.14 Universal synchronous/asynchronous receiver transmitter (USART/UART).....	47
3.15 Inter-IC sound (I2S).....	47
3.16 Universal serial bus on-the-go full-speed (USB OTG FS).....	48
3.17 Universal serial bus on-the-go high-speed (USB OTG HS).....	48
3.18 Controller area network (CAN).....	48
3.19 Ethernet MAC interface.....	49
3.20 External memory controller (EXMC).....	49
3.21 Secure digital input and output card interface (SDIO).....	49
3.22 Digital camera interface (DCI).....	50
3.23 Debug mode.....	50
3.24 Package and operation temperature.....	50
4 Electrical characteristics	51
4.1 Absolute maximum ratings.....	51
4.2 Recommended DC characteristics.....	51

4.3	Power consumption	52
4.4	EMC characteristics.....	53
4.5	Power supply supervisor characteristics	54
4.6	Electrical sensitivity.....	54
4.7	External clock characteristics.....	55
4.8	Internal clock characteristics	56
4.9	PLL characteristics	57
4.10	Memory characteristics	58
4.11	GPIO characteristics.....	59
4.12	ADC characteristics	60
4.13	DAC characteristics	62
4.14	SPI characteristics	63
4.15	I2C characteristics	63
4.16	USART characteristics	63
5	Package information	64
5.1	LQFP package outline dimensions	64
5.2	BGA package outline dimensions	66
6	Ordering information.....	67
7	Revision history	68

List of Figures

Figure 1. GD32F407xx block diagram.....	9
Figure 2. GD32F407Ix BGA176 pinouts	10
Figure 3. GD32F407Vx BGA100 pinouts.....	11
Figure 4. GD32F407Zx LQFP144 pinouts	12
Figure 5. GD32F407Vx LQFP100 pinouts	13
Figure 6. GD32F407Rx LQFP64 pinouts.....	14
Figure 7. GD32F407xx memory map	15
Figure 8. GD32F407xx clock tree.....	18
Figure 9. LQFP package outline.....	64
Figure 10. BGA package outline.....	66

List of Tables

Table 1. GD32F407xx devices features and peripheral list.....	7
Table 2. GD32F407xx pin definitions	19
Table 3. Port A alternate functions summary	31
Table 4. Port B alternate functions summary.....	32
Table 5. Port C alternate functions summary.....	33
Table 6. Port D alternate functions summary.....	34
Table 7. Port E alternate functions summary.....	35
Table 8. Port F alternate functions summary	36
Table 9. Port G alternate functions summary	37
Table 10. Port H alternate functions summary	38
Table 11. Port I alternate functions summary	39
Table 12. Absolute maximum ratings.....	51
Table 13. DC operating conditions	51
Table 14. Power consumption characteristics	52
Table 15. EMS characteristics	53
Table 16. EMI characteristics.....	53
Table 17. Power supply supervisor characteristics	54
Table 18. ESD characteristics.....	54
Table 19. Static latch-up characteristics	54
Table 20. High speed external clock (HXTAL) generated from a crystal/ceramic characteristics	55
Table 21. Low speed external clock (LXTAL) generated from a crystal/ceramic characteristics.....	55
Table 22. High speed internal clock (IRC16M) characteristics	56
Table 23. High speed internal clock (IRC48M) characteristics	56
Table 24. Low speed internal clock (IRC32K) characteristics	57
Table 25. PLL characteristics	57
Table 26. PLL spread spectrum clock generation (SSCG) characteristics	57
Table 27. Flash memory characteristics	58
Table 28. I/O port characteristics.....	59
Table 29. ADC characteristics.....	60
Table 30. ADC $R_{AIN\ max}$ for $f_{ADC}=40MHz$	60
Table 31. ADC dynamic accuracy at $f_{ADC} = 30\ MHz$	61
Table 32. ADC dynamic accuracy at $f_{ADC} = 30\ MHz$	61
Table 33. ADC dynamic accuracy at $f_{ADC} = 36\ MHz$	61
Table 34. ADC dynamic accuracy at $f_{ADC} = 40\ MHz$	61
Table 35. ADC static accuracy at $f_{ADC} = 15\ MHz$	61
Table 36. DAC characteristics	62
Table 37. SPI characteristics.....	63
Table 38. I2C characteristics.....	63
Table 39. USART characteristics	63
Table 40. LQFP package dimensions.....	65
Table 41. BGA package dimensions	66

Table 42. Part ordering code for GD32F407xx devices	67
Table 43. Revision history.....	68

1 Introduction

The GD32F407xx device belongs to the connectivity line of GD32 MCU Family. It is a new 32-bit general-purpose microcontroller based on the ARM® Cortex®-M4 RISC core with best cost-performance ratio in terms of enhanced processing capacity, reduced power consumption and peripheral set. The Cortex®-M4 core features a Floating Point Unit (FPU) that accelerates single precision floating point math operations and supports all ARM® single precision instructions and data types. It implements a full set of DSP instructions to address digital signal control markets that demand an efficient, easy-to-use blend of control and signal processing capabilities. It also provides a Memory Protection Unit (MPU) and powerful trace technology for enhanced application security and advanced debug support.

The GD32F407xx device incorporates the ARM® Cortex®-M4 32-bit processor core operating at 168 MHz frequency with Flash accesses zero wait states to obtain maximum efficiency. It provides up to 3072 KB on-chip Flash memory and 192 KB SRAM memory. An extensive range of enhanced I/Os and peripherals connected to two APB buses. The devices offer up to three 12-bit 2.6M SPS ADCs, two 12-bit DACs, up to eight general-purpose 16-bit timers, two 16-bit PWM advanced-control timers, two 32-bit general-purpose timers, and two 16-bit basic timers, as well as standard and advanced communication interfaces: up to three SPIs, three I2Cs, four USARTs and two UARTs, two I2Ss, two CANs, a SDIO, USB device/host/OTG FS and HS, and an Ethernet MAC. Additional peripherals as Digital camera interface (DCI), EXMC interface with SDRAM extension support are included.

The device operates from a 2.6 to 3.6V power supply and available in –40 to +85 °C temperature range. Three power saving modes provide the flexibility for maximum optimization of power consumption, an especially important consideration in low power applications.

The above features make GD32F407xx devices suitable for a wide range of interconnection and advanced applications, especially in areas such as industrial control, consumer and handheld equipment, embedded modules, human machine interface, security and alarm systems, graphic display, automotive navigation, drone, IoT and so on.



2 Device overview

2.1 Device information

Table 1. GD32F407xx devices features and peripheral list

Part Number		GD32F407xx											
		RE	RG	RK	VE	VG	VK	VE	VG	VK	ZE	ZG	ZK
Flash	Code Area (KB)	512	512	512	512	512	512	512	512	512	512	512	512
	Data Area (KB)	0	512	2560	0	512	2560	0	512	2560	0	512	2560
	Total (KB)	512	1024	3072	512	1024	3072	512	1024	3072	512	1024	3072
SRAM (KB)		192	192	192	192	192	192	192	192	192	192	192	192
Timers	16-bit GPTM	8	8	8	8	8	8	8	8	8	8	8	8
	32-bit GPTM	2	2	2	2	2	2	2	2	2	2	2	2
	Adv. 16-bit TM	2	2	2	2	2	2	2	2	2	2	2	2
	Basic TM	2	2	2	2	2	2	2	2	2	2	2	2
	SysTick	1	1	1	1	1	1	1	1	1	1	1	1
	Watchdog	2	2	2	2	2	2	2	2	2	2	2	2
	RTC	1	1	1	1	1	1	1	1	1	1	1	1
Connectivity	USART+UART	4+2	4+2	4+2	4+2	4+2	4+2	4+2	4+2	4+2	4+2	4+2	4+2
	I2C	3	3	3	3	3	3	3	3	3	3	3	3
	SPI/I2S	3/2	3/2	3/2	3/2	3/2	3/2	3/2	3/2	3/2	3/2	3/2	3/2
	SDIO	1	1	1	1	1	1	1	1	1	1	1	1
	CAN 2.0B	2	2	2	2	2	2	2	2	2	2	2	2
	USB OTG	FS+HS	FS+HS	FS+HS	FS+HS	FS+HS	FS+HS	FS+HS	FS+HS	FS+HS	FS+HS	FS+HS	FS+HS
	Ethernet MAC	1	1	1	1	1	1	1	1	1	1	1	1
	Digital Camera	1	1	1	1	1	1	1	1	1	1	1	1
GPIO		51	51	51	82	82	82	82	82	82	114	114	114
EXMC/SDRAM		0/0	0/0	0/0	1/0	1/0	1/0	1/0	1/0	1/0	1/1	1/1	1/1
ADC Unit (CHs)		3(16)	3(16)	3(16)	3(16)	3(16)	3(16)	3(16)	3(16)	3(16)	3(24)	3(24)	3(24)
DAC		2	2	2	2	2	2	2	2	2	2	2	2
Package		LQFP64			LQFP100			BGA100			LQFP144		

Table 1. GD32F407xx devices features and peripheral list (Cont.)

Part Number		GD32F407xx		
		IE	IG	IK
Flash	Code Area (KB)	512	512	512
	Data Area (KB)	0	512	2560
	Total (KB)	512	1024	3072
SRAM (KB)		192	192	192
Timers	16-bit GPTM	8	8	8
	32-bit GPTM	2	2	2
	Adv. 16-bit TM	2	2	2
	Basic TM	2	2	2
	SysTick	1	1	1
	Watchdog	2	2	2
	RTC	1	1	1
Connectivity	USART+UART	4+2	4+2	4+2
	I2C	3	3	3
	SPI/I2S	3/2	3/2	3/2
	SDIO	1	1	1
	CAN 2.0B	2	2	2
	USB OTG	FS+HS	FS+HS	FS+HS
	Ethernet MAC	1	1	1
	Digital Camera	1	1	1
GPIO		140	140	140
EXMC/SDRAM		1/1	1/1	1/1
ADC Unit (CHs)		3(24)	3(24)	3(24)
DAC		2	2	2
Package		BGA176		

2.2 Block diagram

Figure 1. GD32F407xx block diagram

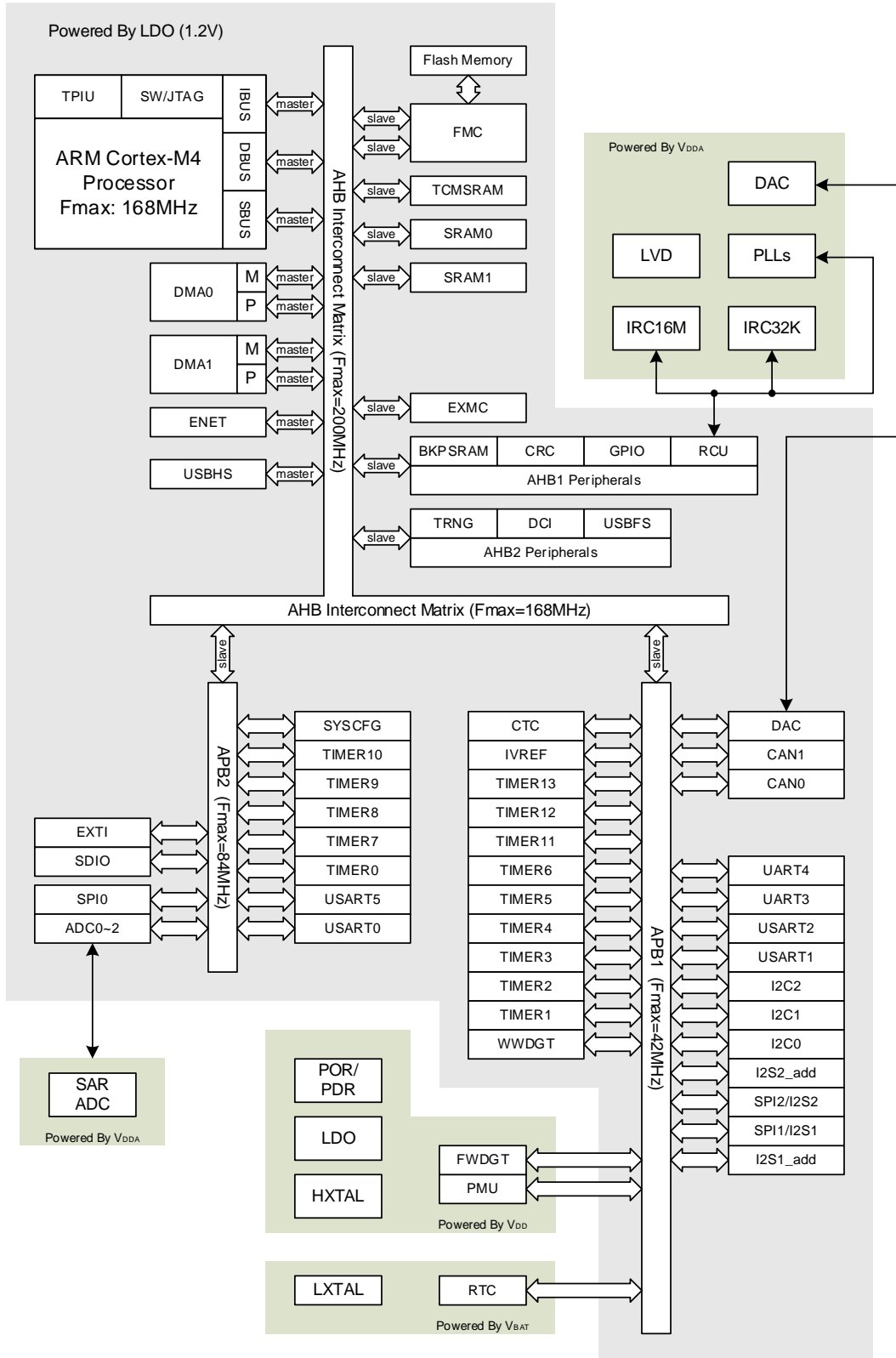

2.3 Pinouts and pin assignment

Figure 2. GD32F4071x BGA176 pinouts

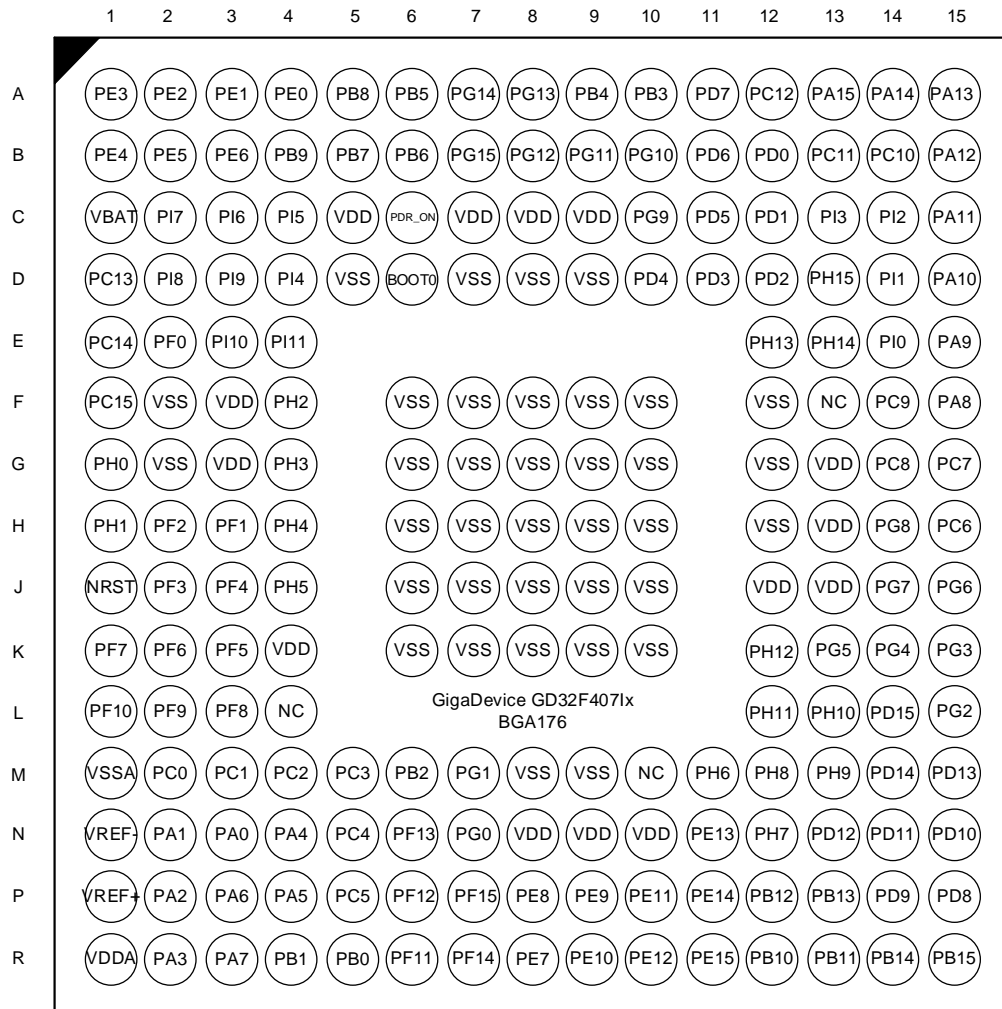

Figure 3. GD32F407Vx BGA100 pinouts



Figure 4. GD32F407Zx LQFP144 pinouts

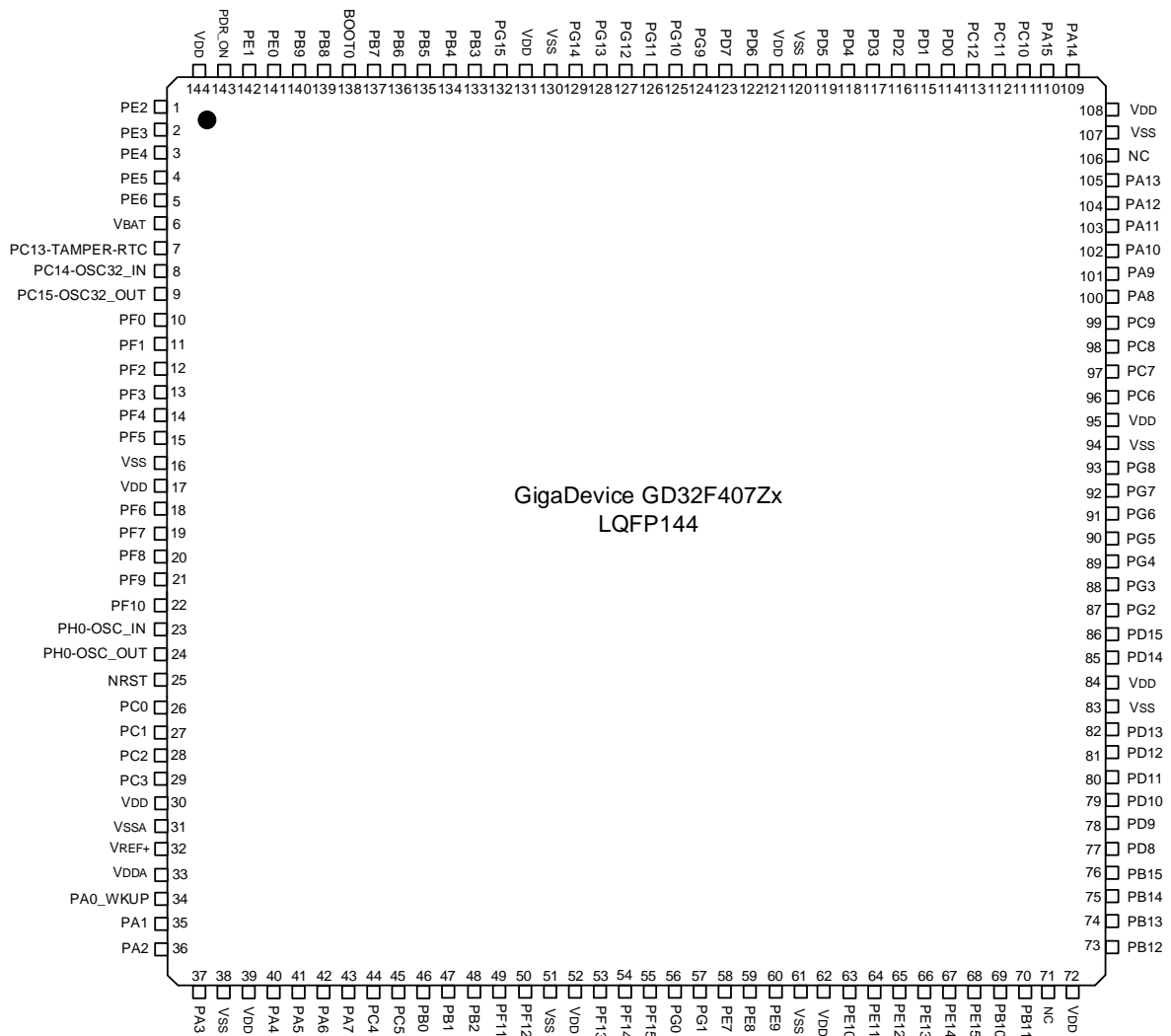

Figure 5. GD32F407Vx LQFP100 pinouts

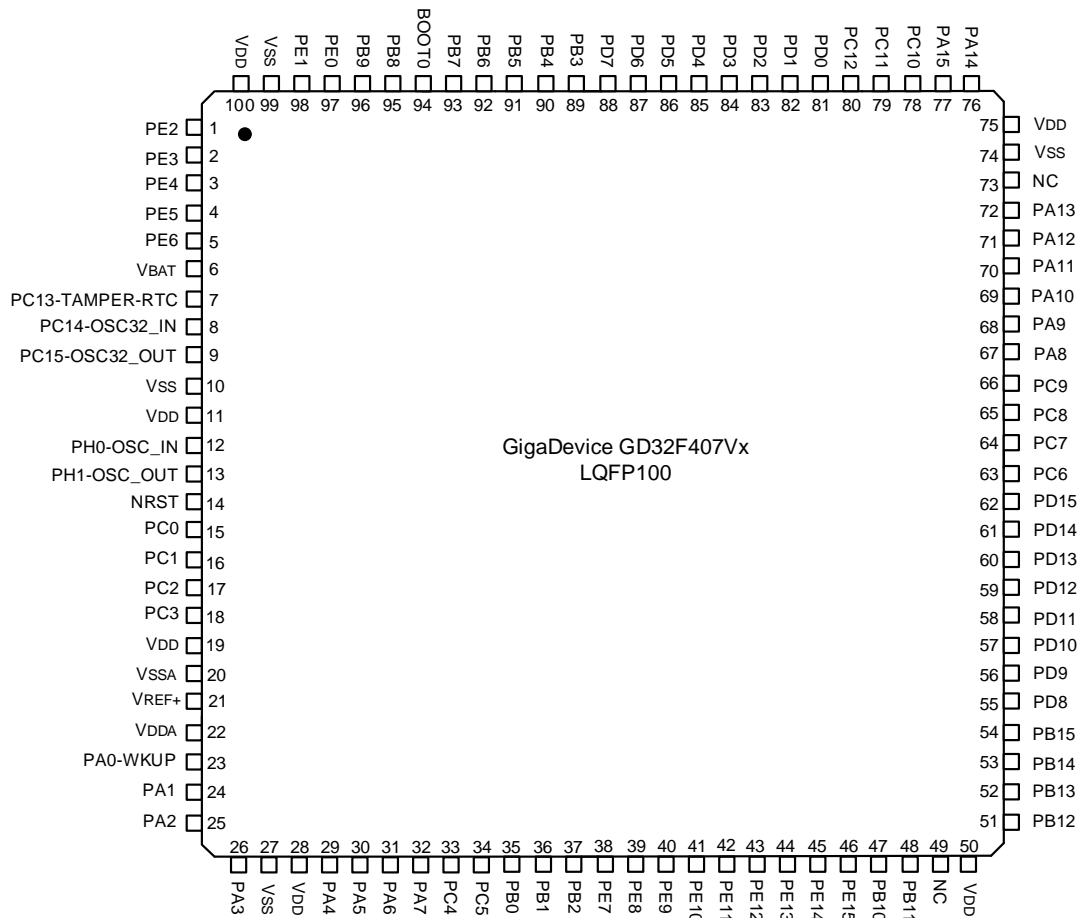
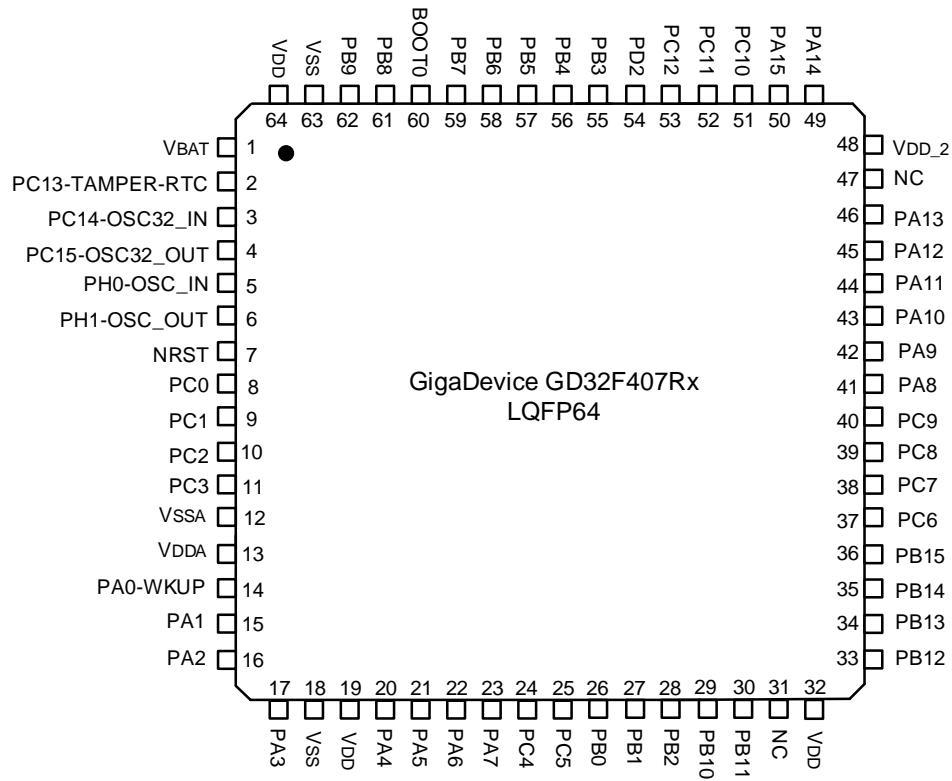

Figure 6. GD32F407Rx LQFP64 pinouts



2.4 Memory map

Figure 7. GD32F407xx memory map

Pre-defined Regions	Bus	Address	Peripherals
External Device	AHB matrix	0xC000 0000 - 0xDFFF FFFF	EXMC - SDRAM
		0xA000 1000 - 0xBFFF FFFF	Reserved
		0xA000 0000 - 0xA000 0FFF	EXMC - SWREG
External RAM		0x9000 0000 - 0x9FFF FFFF	EXMC - PC CARD
		0x7000 0000 - 0x8FFF FFFF	EXMC - NAND
		0x6000 0000 - 0x6FFF FFFF	EXMC - NOR/PSRAM/SRAM
Peripheral	AHB2	0x5006 0C00 - 0x5FFF FFFF	Reserved
		0x5006 0800 - 0x5006 0BFF	TRNG
		0x5005 0400 - 0x5006 07FF	Reserved
		0x5005 0000 - 0x5005 03FF	DCI
		0x5004 0000 - 0x5004 FFFF	Reserved
		0x5000 0000 - 0x5003 FFFF	USBFS
	AHB1	0x4008 0000 - 0x4FFF FFFF	Reserved
		0x4004 0000 - 0x4007 FFFF	USBHS
		0x4002 BC00 - 0x4003 FFFF	Reserved
		0x4002 B000 - 0x4002 BBFF	Reserved
		0x4002 A000 - 0x4002 AFFF	Reserved
		0x4002 8000 - 0x4002 9FFF	ENET
		0x4002 6800 - 0x4002 7FFF	Reserved
		0x4002 6400 - 0x4002 67FF	DMA1
		0x4002 6000 - 0x4002 63FF	DMA0
		0x4002 5000 - 0x4002 5FFF	Reserved
		0x4002 4000 - 0x4002 4FFF	BKPSRAM
		0x4002 3C00 - 0x4002 3FFF	FMC
		0x4002 3800 - 0x4002 3BFF	RCU
		0x4002 3400 - 0x4002 37FF	Reserved
		0x4002 3000 - 0x4002 33FF	CRC
		0x4002 2400 - 0x4002 2FFF	Reserved
		0x4002 2000 - 0x4002 23FF	GPIOI
		0x4002 1C00 - 0x4002 1FFF	GPIOH
		0x4002 1800 - 0x4002 1BFF	GPIOG
		0x4002 1400 - 0x4002 17FF	GPIOF
		0x4002 1000 - 0x4002 13FF	GPIOE
		0x4002 0C00 - 0x4002 0FFF	GPIOD
		0x4002 0800 - 0x4002 0BFF	GPIOC
		0x4002 0400 - 0x4002 07FF	GPIOB
		0x4002 0000 - 0x4002 03FF	GPIOA

Pre-defined Regions	Bus	Address	Peripherals
	APB2	0x4001 6C00 - 0x4001 FFFF	Reserved
		0x4001 6800 - 0x4001 6BFF	Reserved
		0x4001 5800 - 0x4001 67FF	Reserved
		0x4001 5400 - 0x4001 57FF	Reserved
		0x4001 5000 - 0x4001 53FF	Reserved
		0x4001 4C00 - 0x4001 4FFF	Reserved
		0x4001 4800 - 0x4001 4BFF	TIMER10
		0x4001 4400 - 0x4001 47FF	TIMER9
		0x4001 4000 - 0x4001 43FF	TIMER8
		0x4001 3C00 - 0x4001 3FFF	EXTI
		0x4001 3800 - 0x4001 3BFF	SYSCFG
		0x4001 3400 - 0x4001 37FF	Reserved
		0x4001 3000 - 0x4001 33FF	SPI0
		0x4001 2C00 - 0x4001 2FFF	SDIO
		0x4001 2400 - 0x4001 2BFF	Reserved
		0x4001 2000 - 0x4001 23FF	ADC
		0x4001 1800 - 0x4001 1FFF	Reserved
		0x4001 1400 - 0x4001 17FF	USART5
		0x4001 1000 - 0x4001 13FF	USART0
		0x4001 0800 - 0x4001 0FFF	Reserved
	0x4001 0400 - 0x4001 07FF	TIMER7	
	0x4001 0000 - 0x4001 03FF	TIMER0	
	APB1	0x4000 C800 - 0x4000 FFFF	Reserved
		0x4000 C400 - 0x4000 C7FF	IVREF
		0x4000 8000 - 0x4000 C3FF	Reserved
		0x4000 7C00 - 0x4000 7FFF	Reserved
		0x4000 7800 - 0x4000 7BFF	Reserved
		0x4000 7400 - 0x4000 77FF	DAC
		0x4000 7000 - 0x4000 73FF	PMU
		0x4000 6C00 - 0x4000 6FFF	CTC
		0x4000 6800 - 0x4000 6BFF	CAN1
		0x4000 6400 - 0x4000 67FF	CAN0
		0x4000 6000 - 0x4000 63FF	Reserved
		0x4000 5C00 - 0x4000 5FFF	I2C2
		0x4000 5800 - 0x4000 5BFF	I2C1
		0x4000 5400 - 0x4000 57FF	I2C0
0x4000 5000 - 0x4000 53FF		UART4	
0x4000 4C00 - 0x4000 4FFF		UART3	
0x4000 4800 - 0x4000 4BFF	USART2		
0x4000 4400 - 0x4000 47FF	USART1		

Pre-defined Regions	Bus	Address	Peripherals
		0x4000 4000 - 0x4000 43FF	I2S2_add
		0x4000 3C00 - 0x4000 3FFF	SPI2/I2S2
		0x4000 3800 - 0x4000 3BFF	SPI1/I2S1
		0x4000 3400 - 0x4000 37FF	I2S1_add
		0x4000 3000 - 0x4000 33FF	FWDGT
		0x4000 2C00 - 0x4000 2FFF	WWDGT
		0x4000 2800 - 0x4000 2BFF	RTC
		0x4000 2400 - 0x4000 27FF	Reserved
		0x4000 2000 - 0x4000 23FF	TIMER13
		0x4000 1C00 - 0x4000 1FFF	TIMER12
		0x4000 1800 - 0x4000 1BFF	TIMER11
		0x4000 1400 - 0x4000 17FF	TIMER6
		0x4000 1000 - 0x4000 13FF	TIMER5
		0x4000 0C00 - 0x4000 0FFF	TIMER4
		0x4000 0800 - 0x4000 0BFF	TIMER3
		0x4000 0400 - 0x4000 07FF	TIMER2
0x4000 0000 - 0x4000 03FF	TIMER1		
SRAM	AHB matrix	0x2007 0000 - 0x3FFF FFFF	Reserved
		0x2003 0000 - 0x2006 FFFF	Reserved
		0x2002 0000 - 0x2002 FFFF	Reserved
		0x2001 C000 - 0x2001 FFFF	SRAM1(16KB)
		0x2000 0000 - 0x2001 BFFF	SRAM0(112KB)
Code	AHB matrix	0x1FFF C010 - 0x1FFF FFFF	Reserved
		0x1FFF C000 - 0x1FFF C00F	Option bytes(Bank 0)
		0x1FFF 7A10 - 0x1FFF BFFF	Reserved
		0x1FFF 7800 - 0x1FFF 7A0F	OTP(528B)
		0x1FFF 0000 - 0x1FFF 77FF	Boot loader(30KB)
		0x1FFE C010 - 0x1FFE FFFF	Reserved
		0x1FFE C000 - 0x1FFE C00F	Option bytes(Bank 1)
		0x1001 0000 - 0x1FFE BFFF	Reserved
		0x1000 0000 - 0x1000 FFFF	TCMSRAM(64KB)
		0x0830 0000 - 0x0FFF FFFF	Reserved
		0x0800 0000 - 0x082F FFFF	Main Flash(3072KB)
		0x0000 0000 - 0x07FF FFFF	Aliased to the boot device

2.5 Clock tree

Figure 8. GD32F407xx clock tree

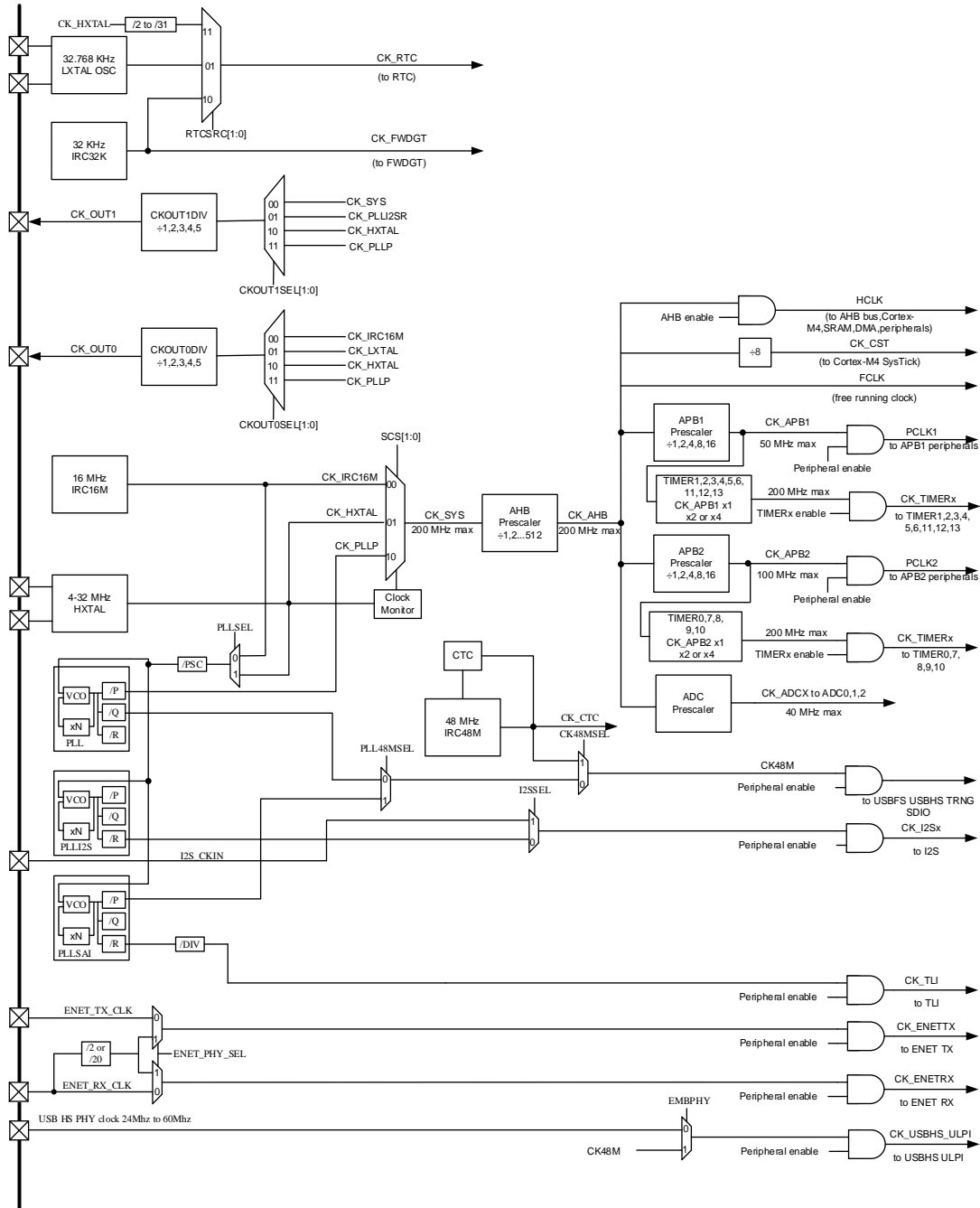

Legend:

- HXTAL:** High speed crystal oscillator
- LXTAL:** Low speed crystal oscillator
- IRC16M:** Internal 16M RC oscillators
- IRC48M:** Internal 48M RC oscillators
- IRC32K:** Internal 32K RC oscillator

2.6 Pin definitions

Table 2. GD32F407xx pin definitions

Pin Name	Pins					Pin Type ⁽¹⁾	I/O ⁽²⁾ Level	Functions description
	BGA176	BGA100	LQFP144	LQFP100	LQFP64			
PE2	A2	B2	1	1	-	I/O	5VT	Default: PE2 Alternate: TRACECLK, ETH_MII_TXD3, EXMC_A23, EVENTOUT
PE3	A1	A1	2	2	-	I/O	5VT	Default: PE3 Alternate: TRACED0, EXMC_A19, EVENTOUT
PE4	B1	B1	3	3	-	I/O	5VT	Default: PE4 Alternate: TRACED1, EXMC_A20, DCI_D4, EVENTOUT
PE5	B2	C2	4	4	-	I/O	5VT	Default: PE5 Alternate: TRACED2, TIMER8_CH0, EXMC_A21, DCI_D6, EVENTOUT
PE6	B3	D2	5	5	-	I/O	5VT	Default: PE6 Alternate: TRACED3, TIMER8_CH1, EXMC_A22, DCI_D7, EVENTOUT
V _{BAT}	C1	E2	6	6	1	P	-	Default: V _{BAT}
PI8	D2	-	-	-	-	I/O	5VT	Default: PI8 Alternate: EVENTOUT Additional: RTC_TAMP1, RTC_TAMP0, RTC_TS
PC13- TAMPER- RTC	D1	C1	7	7	2	I/O	5VT	Default: PC13 Alternate: EVENTOUT Additional: RTC_TAMP0, RTC_OUT, RTC_TS
PC14- OSC32IN	E1	D1	8	8	3	I/O	5VT	Default: PC14 Alternate: EVENTOUT Additional: OSC32IN
PC15- OSC32OUT	F1	E1	9	9	4	I/O	5VT	Default: PC15 Alternate: EVENTOUT Additional: OSC32OUT
PI9	D3	-	-	-	-	I/O	5VT	Default: PI9 Alternate: CAN0_RX, EXMC_D30, EVENTOUT
PI10	E3	-	-	-	-	I/O	5VT	Default: PI10 Alternate: ETH_MII_RX_ER, EXMC_D31, EVENTOUT
PI11	E4	-	-	-	-	I/O	5VT	Default: PI11 Alternate: USBHS_ULPI_DIR, EVENTOUT
V _{SS}	F2	-	-	-	-	P	-	Default: V _{SS}
V _{DD}	F3	-	-	-	-	P	-	Default: V _{DD}
PF0	E2	-	10	-	-	I/O	5VT	Default: PF0 Alternate: I2C1_SDA, EXMC_A0, EVENTOUT, CTC_SYNC

Pin Name	Pins					Pin Type ⁽¹⁾	I/O ⁽²⁾ Level	Functions description
	BGA176	BGA100	LQFP144	LQFP100	LQFP64			
PF1	H3	-	11	-	-	I/O	5VT	Default: PF1 Alternate: I2C1_SCL, EXMC_A1, EVENTOUT
PF2	H2	-	12	-	-	I/O	5VT	Default: PF2 Alternate: I2C1_SMBA, EXMC_A2, EVENTOUT
PF3	J2	-	13	-	-	I/O	5VT	Default: PF3 Alternate: EXMC_A3, EVENTOUT, I2C1_TXFRAME Additional: ADC2_IN9
PF4	J3	-	14	-	-	I/O	5VT	Default: PF4 Alternate: EXMC_A4, EVENTOUT Additional: ADC2_IN14
PF5	K3	-	15	-	-	I/O	5VT	Default: PF5 Alternate: EXMC_A5, EVENTOUT Additional: ADC2_IN15
V _{SS}	G2	F2	16	10	-	P	-	Default: V _{SS}
V _{DD}	G3	G2	17	11	-	P	-	Default: V _{DD}
PF6	K2	-	18	-	-	I/O	5VT	Default: PF6 Alternate: TIMER9_CH0, EXMC_NIORD, EVENTOUT Additional: ADC2_IN4
PF7	K1	-	19	-	-	I/O	5VT	Default: PF7 Alternate: TIMER10_CH0, EXMC_NREG, EVENTOUT Additional: ADC2_IN5
PF8	L3	-	20	-	-	I/O	5VT	Default: PF8 Alternate: TIMER12_CH0, EXMC_NIOWR, EVENTOUT Additional: ADC2_IN6
PF9	L2	-	21	-	-	I/O	5VT	Default: PF9 Alternate: TIMER13_CH0, EXMC_CD, EVENTOUT Additional: ADC2_IN7
PF10	L1	-	22	-	-	I/O	5VT	Default: PF10 Alternate: EXMC_INTR, DCI_D11, EVENTOUT Additional: ADC2_IN8
PH0	G1	F1	23	12	5	I/O	5VT	Default: PH0, OSCIN Alternate: EVENTOUT Additional: OSCIN
PH1	H1	G1	24	13	6	I/O	5VT	Default: PH1, OSCOUT Alternate: EVENTOUT Additional: OSCOUT
NRST	J1	H2	25	14	7	-	-	Default: NRST
PC0	M2	H1	26	15	8	I/O	5VT	Default: PC0 Alternate: USBHS_ULPI_STP, EXMC_SDNWE, EVENTOUT

Pin Name	Pins					Pin Type ⁽¹⁾	I/O ⁽²⁾ Level	Functions description
	BGA176	BGA100	LQFP144	LQFP100	LQFP64			
								Additional: ADC012_IN10
PC1	M3	J2	27	16	9	I/O	5VT	Default: PC1 Alternate:SPI2_MOSI, I2S2_SD, SPI1_MOSI, I2S1_SD, ETH_MDC, EVENTOUT Additional: ADC012_IN11
PC2	M4	J3	28	17	10	I/O	5VT	Default: PC2 Alternate:SPI1_MISO,I2S1_ADD_SD,USBHS_ULPI_DIR, ETH_MII_TXD2, EXMC_SDNE0, EVENTOUT Additional: ADC012_IN12
PC3	M5	K2	29	18	11	I/O	5VT	Default: PC3 Alternate:SPI1_MOSI,I2S1_SD,USBHS_ULPI_NXT, ETH_MII_TX_CLK, EXMC_SDCKE0, EVENTOUT Additional: ADC012_IN13
V _{DD}	G3	-	30	19	-	P	-	Default: V _{DD}
V _{SSA}	M1	J1	31	20	12	P	-	Default: V _{SSA}
V _{REFN}	N1	K1	-	-	-	P	-	Default: V _{REF-}
V _{REFP}	P1	L1	32	21	-	P	-	Default: V _{REF+}
V _{DDA}	R1	M1	33	22	13	P	-	Default: V _{DDA}
PA0-WKUP	N3	L2	34	23	14	I/O	5VT	Default: PA0 Alternate:TIMER1_CH0,TIMER1_ETI,TIMER4_CH0, TIMER7_ETI,USART1_CTS, UART3_TX, ETH_MII_CRS, EVENTOUT Additional: ADC012_IN0, WKUP
PA1	N2	M2	35	24	15	I/O	5VT	Default: PA1 Alternate:TIMER1_CH1, TIMER4_CH1, USART1_RTS, UART3_RX, ETH_MII_RX_CLK, ETH_RMII_REF_CLK, EVENTOUT Additional: ADC012_IN1
PA2	P2	K3	36	25	16	I/O	5VT	Default: PA2 Alternate:TIMER1_CH2,TIMER4_CH2,TIMER8_CH0, I2S_CKIN, USART1_TX, ETH_MDIO, EVENTOUT Additional: ADC012_IN2
PH2	F4	-	-	-	-	I/O	5VT	Default: PH2 Alternate: ETH_MII_CRS, EXMC_SDCKE0, EVENTOUT
PH3	G4	-	-	-	-	I/O	5VT	Default: PH3 Alternate: ETH_MII_COL, EXMC_SDNE0, EVENTOUT, I2C1_TXFRAME
PH4	H4	-	-	-	-	I/O	5VT	Default: PH4 Alternate: I2C1_SCL, USBHS_ULPI_NXT, EVENTOUT

Pin Name	Pins					Pin Type ⁽¹⁾	I/O ⁽²⁾ Level	Functions description
	BGA176	BGA100	LQFP144	LQFP100	LQFP64			
PH5	J4	-	-	-	-	I/O	5VT	Default: PH5 Alternate: I2C1_SDA, EXMC_SDNWE, EVENTOUT
PA3	R2	L3	37	26	17	I/O	5VT	Default: PA3 Alternate: TIMER1_CH3, TIMER4_CH3, TIMER8_CH1, I2S1_MCK, USART1_RX, USBHS_ULPI_D0, ETH_MII_COL, EVENTOUT Additional: ADC012_IN3
V _{SS}	-	-	38	27	18	P	-	Default: V _{SS}
NC	L4	E3	-	-	-	-	-	-
V _{DD}	K4	-	39	28	19	P	-	Default: V _{DD}
PA4	N4	M3	40	29	20	I/O	TTa	Default: PA4 Alternate: SPI0_NSS, SPI2_NSS, I2S2_WS, USART1_CK, USBHS_SOF, DCI_HSYNC, EVENTOUT Additional: ADC01_IN4, DAC_OUT0
PA5	P4	K4	41	30	21	I/O	TTa	Default: PA5 Alternate: TIMER1_CH0, TIMER1_ETI, TIMER7_CH0_ON, SPI0_SCK, USBHS_ULPI_CK, EVENTOUT Additional: ADC01_IN5, DAC_OUT1
PA6	P3	L4	42	31	22	I/O	5VT	Default: PA6 Alternate: TIMER0_BRKIN, TIMER2_CH0, TIMER7_BRKIN, SPI0_MI SO, I2S1_MCK, TIMER12_CH0, SDIO_CMD, DCI_PIXCLK, EVENTOUT Additional: ADC01_IN6
PA7	R3	M4	43	32	23	I/O	5VT	Default: PA7 Alternate: TIMER0_CH0_ON, TIMER2_CH1, TIMER7_CH0_ON, SPI0_MOSI, TIMER13_CH0, ETH_MII_RX_DV, ETH_RMII_CRS_DV, EXMC_SDNWE, EVENTOUT Additional: ADC01_IN7
PC4	N5	K5	44	33	24	I/O	5VT	Default: PC4 Alternate: ETH_MII_RXD0, ETH_RMII_RXD0, EXMC_SDNE0, EVENTOUT Additional: ADC01_IN14
PC5	P5	L5	45	34	25	I/O	5VT	Default: PC5 Alternate: USART2_RX, ETH_MII_RXD1, ETH_RMII_RXD1, EXMC_SDCKE0, EVENTOUT Additional: ADC01_IN15
PB0	R5	M5	46	35	26	I/O	5VT	Default: PB0 Alternate: TIMER0_CH1_ON, TIMER2_CH2, TIMER7_CH1_ON, SPI 2_MOSI, I2S2_SD, USBHS_ULPI_D1, ETH_MII_RXD2, SDIO_D1, E

Pin Name	Pins					Pin Type ⁽¹⁾	I/O ⁽²⁾ Level	Functions description
	BGA176	BGA100	LQFP144	LQFP100	LQFP64			
								VENTOUT Additional: ADC01_IN8, IREF
PB1	R4	M6	47	36	27	I/O	5VT	Default: PB1 Alternate:TIMER0_CH2_ON,TIMER2_CH3,TIMER7_CH2_ON,US BHS_ULPI_D2,ETH_MII_RXD3,SDIO_D2, EVENTOUT Additional: ADC01_IN9
PB2	M6	L6	48	37	28	I/O	5VT	Default: PB2, BOOT1 Alternate:TIMER1_CH3,SPI2_MOSI,I2S2_SD,USBHS_ULPI_D4, SDIO_CK, EVENTOUT
PF11	R6	-	49	-	-	I/O	5VT	Default: PF11 Alternate: EXMC_SDNRAS, DCI_D12, EVENTOUT
PF12	P6	-	50	-	-	I/O	5VT	Default: PF12 Alternate: EXMC_A6, EVENTOUT
V _{SS}	M8	-	51	-	-	P	-	Default: V _{SS}
V _{DD}	N8	-	52	-	-	P	-	Default: V _{DD}
PF13	N6	-	53	-	-	I/O	5VT	Default: PF13 Alternate: EXMC_A7, EVENTOUT
PF14	R7	-	54	-	-	I/O	5VT	Default: PF14 Alternate: EXMC_A8, EVENTOUT
PF15	P7	-	55	-	-	I/O	5VT	Default: PF15 Alternate: EXMC_A9, EVENTOUT
PG0	N7	-	56	-	-	I/O	5VT	Default: PG0 Alternate: EXMC_A10, EVENTOUT
PG1	M7	-	57	-	-	I/O	5VT	Default: PG1 Alternate: EXMC_A11, EVENTOUT
PE7	R8	M7	58	38	-	I/O	5VT	Default: PE7 Alternate: TIMER0_ETI, EXMC_D4, EVENTOUT
PE8	P8	L7	59	39	-	I/O	5VT	Default: PE8 Alternate: TIMER0_CH0_ON, EXMC_D5, EVENTOUT
PE9	P9	M8	60	40	-	I/O	5VT	Default: PE9 Alternate: TIMER0_CH0, EXMC_D6, EVENTOUT
V _{SS}	M9	-	61	-	-	P	-	Default: V _{SS}
V _{DD}	N9	-	62	-	-	P	-	Default: V _{DD}
PE10	R9	L8	63	41	-	I/O	5VT	Default: PE10 Alternate: TIMER0_CH1_ON, EXMC_D7, EVENTOUT
PE11	P10	M9	64	42	-	I/O	5VT	Default: PE11 Alternate:TIMER0_CH1, EXMC_D8, EVENTOUT
PE12	R10	L9	65	43	-	I/O	5VT	Default: PE12 Alternate:TIMER0_CH2_ON, EXMC_D9, EVENTOUT

Pin Name	Pins					Pin Type ⁽¹⁾	I/O ⁽²⁾ Level	Functions description
	BGA176	BGA100	LQFP144	LQFP100	LQFP64			
PE13	N11	M10	66	44	-	I/O	5VT	Default: PE13 Alternate:TIMER0_CH2, EXMC_D10, EVENTOUT
PE14	P11	M11	67	45	-	I/O	5VT	Default: PE14 Alternate:TIMER0_CH3, EXMC_D11, EVENTOUT
PE15	R11	M12	68	46	-	I/O	5VT	Default: PE15 Alternate: TIMER0_BRKIN, EXMC_D12, EVENTOUT
PB10	R12	L10	69	47	29	I/O	5VT	Default: PB10 Alternate:TIMER1_CH2,I2C1_SCL, SPI1_SCK, I2S1_CK, I2S2_MCK,USART2_TX,USBHS_ULPI_D3, ETH_MII_RX_ER, SDIO_D7, EVENTOUT
PB11	R13	K9	70	48	30	I/O	5VT	Default: PB11 Alternate:TIMER1_CH3,I2C1_SDA,I2S_CKIN,USART2_RX,USBH S_ULPI_D4,ETH_MII_TX_EN,ETH_RMII_TX_EN, EVENTOUT
NC	M10	L11	71	49	31	P	-	Default: V _{CORE}
V _{SS}	-	F12	-	-	-	P	-	Default: V _{SS}
V _{DD}	N10	G12	72	50	32	P	-	Default: V _{DD}
PH6	M11	-	-	-	-	I/O	5VT	Default: PH6 Alternate:I2C1_SMBA, TIMER11_CH0, ETH_MII_RXD2, EXMC_SDNE1, DCI_D8, EVENTOUT
PH7	N12	-	-	-	-	I/O	5VT	Default: PH7 Alternate:I2C2_SCL,ETH_MII_RXD3,EXMC_SDCKE1, DCI_D9, EVENTOUT
PH8	M12	-	-	-	-	I/O	5VT	Default: PH8 Alternate:I2C2_SDA,EXMC_D16,DCI_HSYNC,EVENTOUT
PH9	M13	-	-	-	-	I/O	5VT	Default: PH9 Alternate:I2C2_SMBA,TIMER11_CH1,EXMC_D17,DCI_D0, EVENTOUT
PH10	L13	-	-	-	-	I/O	5VT	Default: PH10 Alternate:TIMER4_CH0,EXMC_D18,DCI_D1,EVENTOUT, I2C2_TXFRAME
PH11	L12	-	-	-	-	I/O	5VT	Default: PH11 Alternate:TIMER4_CH1,EXMC_D19,DCI_D2,EVENTOUT
PH12	K12	-	-	-	-	I/O	5VT	Default: PH12 Alternate:TIMER4_CH2,EXMC_D20,DCI_D3,EVENTOUT
V _{SS}	H12	-	-	-	-	P	-	Default: V _{SS}
V _{DD}	J12	-	-	-	-	P	-	Default: V _{DD}
PB12	P12	L12	73	51	33	I/O	5VT	Default: PB12 Alternate:TIMER0_BRKIN,I2C1_SMBA,SPI1_NSS, I2S1_WS,USART2_CK,CAN1_RX,USBHS_ULPI_D5,

Pin Name	Pins					Pin Type ⁽¹⁾	I/O ⁽²⁾ Level	Functions description
	BGA176	BGA100	LQFP144	LQFP100	LQFP64			
								ETH_MII_TXD0,ETH_RMII_TXD0,USBHS_ID, EVENTOUT
PB13	P13	K12	74	52	34	I/O	5VT	Default: PB13 Alternate:TIMER0_CH0_ON,SPI1_SCK,I2S1_CK, USART2_CTS,CAN1_TX,USBHS_ULPI_D6, ETH_MII_TXD1,ETH_RMII_TXD1,EVENTOUT, I2C1_TXFRAME Additional: USBHS_VBUS
PB14	R14	K11	75	53	35	I/O	5VT	Default: PB14 Alternate:TIMER0_CH1_ON,TIMER7_CH1_ON,SPI1_MISO,I2S1_ADD_SD,USART2_RTS,TIMER11_CH0,USBHS_DM, EVENTOUT
PB15	R15	K10	76	54	36	I/O	5VT	Default: PB15 Alternate:RTC_REFIN,TIMER0_CH2_ON,TIMER7_CH2_ON, SPI1_MOSI, I2S1_SD, TIMER11_CH1, USBHS_DP, EVENTOUT
PD8	P15	-	77	55	-	I/O	5VT	Default: PD8 Alternate: USART2_TX, EXMC_D13, EVENTOUT
PD9	P14	K8	78	56	-	I/O	5VT	Default: PD9 Alternate: USART2_RX, EXMC_D14, EVENTOUT
PD10	N15	J12	79	57	-	I/O	5VT	Default: PD10 Alternate: USART2_CK, EXMC_D15, EVENTOUT
PD11	N14	J11	80	58	-	I/O	5VT	Default: PD11 Alternate: USART2_CTS, EXMC_A16, EVENTOUT
PD12	N13	J10	81	59	-	I/O	5VT	Default: PD12 Alternate:TIMER3_CH0,USART2_RTS,EXMC_A17, EVENTOUT
PD13	M15	H12	82	60	-	I/O	5VT	Default: PD13 Alternate: TIMER3_CH1, EXMC_A18, EVENTOUT
V _{SS}	-	-	83	-	-	P	-	Default: V _{SS}
V _{DD}	J13	-	84	-	-	P	-	Default: V _{DD}
PD14	M14	H11	85	61	-	I/O	5VT	Default: PD14 Alternate: TIMER3_CH2, EXMC_D0, EVENTOUT
PD15	L14	H10	86	62	-	I/O	5VT	Default: PD15 Alternate:TIMER3_CH3,EXMC_D1,EVENTOUT,CTC_SYNC
PG2	L15	-	87	-	-	I/O	5VT	Default: PG2 Alternate:EXMC_A12, EVENTOUT
PG3	K15	-	88	-	-	I/O	5VT	Default: PG3 Alternate: EXMC_A13, EVENTOUT
PG4	K14	-	89	-	-	I/O	5VT	Default: PG4 Alternate: EXMC_A14, EVENTOUT
PG5	K13	-	90	-	-	I/O	5VT	Default: PG5 Alternate: EXMC_A15, EVENTOUT

Pin Name	Pins					Pin Type ⁽¹⁾	I/O ⁽²⁾ Level	Functions description
	BGA176	BGA100	LQFP144	LQFP100	LQFP64			
PG6	J15	-	91	-	-	I/O	5VT	Default: PG6 Alternate: EXMC_INT1, DCI_D12, EVENTOUT
PG7	J14	-	92	-	-	I/O	5VT	Default: PG7 Alternate: USART5_CK, EXMC_INT2, DCI_D13, EVENTOUT
PG8	H14	-	93	-	-	I/O	5VT	Default: PG8 Alternate: USART5_RTS, ETH_PPS_OUT, EXMC_SDCLK, EVENTOUT
V _{SS}	G12	-	94	-	-	P	-	Default: V _{SS}
V _{DD}	H13	-	95	-	-	P	-	Default: V _{DD}
PC6	H15	E12	96	63	37	I/O	5VT	Default: PC6 Alternate: TIMER2_CH0, TIMER7_CH0, I2S1_MCK, USART5_TX, SDIO_D6, DCI_D0, EVENTOUT
PC7	G15	E11	97	64	38	I/O	5VT	Default: PC7 Alternate: TIMER2_CH1, TIMER7_CH1, SPI1_SCK, I2S1_CK, I2S2_MCK, USART5_RX, SDIO_D7, DCI_D1, EVENTOUT
PC8	G14	E10	98	65	39	I/O	5VT	Default: PC8 Alternate: TRACED0, TIMER2_CH2, TIMER7_CH2, USART5_CK, SDIO_D0, DCI_D2, EVENTOUT
PC9	F14	D12	99	66	40	I/O	5VT	Default: PC9 Alternate: CK_OUT1, TIMER2_CH3, TIMER7_CH3, I2C2_SDA, I2S_CKIN, SDIO_D1, DCI_D3, EVENTOUT
PA8	F15	D11	100	67	41	I/O	5VT	Default: PA8 Alternate: CK_OUT0, TIMER0_CH0, I2C2_SCL, USART0_CK, USBFS_SOF, SDIO_D1, EVENTOUT, CTC_SYNC
PA9	E15	D10	101	68	42	I/O	5VT	Default: PA9 Alternate: TIMER0_CH1, I2C2_SMBA, SPI1_SCK, I2S1_CK, USART0_TX, SDIO_D2, DCI_D0, EVENTOUT Additional: USBFS_VBUS
PA10	D15	C12	102	69	43	I/O	5VT	Default: PA10 Alternate: TIMER0_CH2, USART0_RX, USBFS_ID, DCI_D1, EVENTOUT, I2C2_TXFRAME
PA11	C15	B12	103	70	44	I/O	5VT	Default: PA11 Alternate: TIMER0_CH3, USART0_CTS, USART5_TX, CAN0_RX, USBFS_DM, EVENTOUT
PA12	B15	A12	104	71	45	I/O	5VT	Default: PA12 Alternate: TIMER0_ETI, USART0_RTS, USART5_RX, CAN0_TX, USBFS_DP, EVENTOUT
PA13	A15	A11	105	72	46	I/O	5VT	Default: JTMS, SWDIO, PA13 Alternate: EVENTOUT

Pin Name	Pins					Pin Type ⁽¹⁾	I/O ⁽²⁾ Level	Functions description
	BGA176	BGA100	LQFP144	LQFP100	LQFP64			
NC	F13	C11	106	73	47	-	-	-
V _{SS}	F12	F11	107	74	-	P	-	Default: V _{SS}
V _{DD}	G13	G11	108	75	48	P	-	Default: V _{DD}
PH13	E12	-	-	-	-	I/O	5VT	Default: PH13 Alternate: TIMER7_CH0_ON, CAN0_TX, EXMC_D21, EVENTOUT
PH14	E13	-	-	-	-	I/O	5VT	Default: PH14 Alternate: TIMER7_CH1_ON, EXMC_D22, DCI_D4, EVENTOUT
PH15	D13	-	-	-	-	I/O	5VT	Default: PH15 Alternate: TIMER7_CH2_ON, EXMC_D23, DCI_D11, EVENTOUT
PI0	E14	-	-	-	-	I/O	5VT	Default: PI0 Alternate: TIMER4_CH3, SPI1_NSS, I2S1_WS, EXMC_D24, DCI_D13, EVENTOUT
PI1	D14	-	-	-	-	I/O	5VT	Default: PI1 Alternate: SPI1_SCK, I2S1_CK, EXMC_D25, DCI_D8, EVENTOUT
PI2	C14	-	-	-	-	I/O	5VT	Default: PI2 Alternate: TIMER7_CH3, SPI1_MISO, I2S1_ADD_SD, EXMC_D26, DCI_D9, EVENTOUT
PI3	C13	-	-	-	-	I/O	5VT	Default: PI3 Alternate: TIMER7_ETI, SPI1_MOSI, I2S1_SD, EXMC_D27, DCI_D10, EVENTOUT
V _{SS}	D9	-	-	-	-	P	-	Default: V _{SS}
V _{DD}	C9	-	-	-	-	P	-	Default: V _{DD}
PA14	A14	A10	109	76	49	I/O	5VT	Default: JTCK, SWCLK, PA14 Alternate: EVENTOUT
PA15	A13	A9	110	77	50	I/O	5VT	Default: JTDI, PA15 Alternate: TIMER1_CH0, TIMER1_ETI, SPI0_NSS, SPI2_NSS, I2S2_WS, USART0_TX, EVENTOUT
PC10	B14	B11	111	78	51	I/O	5VT	Default: PC10 Alternate: SPI2_SCK, I2S2_CK, USART2_TX, UART3_TX, SDIO_D2, DCI_D8, EVENTOUT
PC11	B13	C10	112	79	52	I/O	5VT	Default: PC11 Alternate: I2S2_ADD_SD, SPI2_MISO, USART2_RX, UART3_RX, SDIO_D3, DCI_D4, EVENTOUT
PC12	A12	B10	113	80	53	I/O	5VT	Default: PC12 Alternate: I2C1_SDA, SPI2_MOSI, I2S2_SD, USART2_CK, UART4_TX, SDIO_CK, DCI_D9, EVENTOUT
PD0	B12	C9	114	81	-	I/O	5VT	Default: PD0 Alternate: SPI2_MOSI, I2S2_SD, CAN0_RX, EXMC_D2, EVENTOUT

Pin Name	Pins					Pin Type ⁽¹⁾	I/O ⁽²⁾ Level	Functions description
	BGA176	BGA100	LQFP144	LQFP100	LQFP64			
PD1	C12	B9	115	82	-	I/O	5VT	Default: PD1 Alternate: SPI1_NSS, I2S1_WS, CAN0_TX, EXMC_D3, EVENTOUT
PD2	D12	C8	116	83	54	I/O	5VT	Default: PD2 Alternate: TIMER2_ETI, UART4_RX, SDIO_CMD, DCI_D11, EVENTOUT
PD3	D11	B8	117	84	-	I/O	5VT	Default: PD3 Alternate: TRACED1, SPI1_SCK, I2S1_CK, USART1_CTS, EXMC_CLK, DCI_D5, EVENTOUT
PD4	D10	B7	118	85	-	I/O	5VT	Default: PD4 Alternate: USART1_RTS, EXMC_NOE, EVENTOUT
PD5	C11	A6	119	86	-	I/O	5VT	Default: PD5 Alternate: USART1_TX, EXMC_NWE, EVENTOUT
V _{SS}	D8	-	120	-	-	P	-	Default: V _{SS}
V _{DD}	C8	-	121	-	-	P	-	Default: V _{DD}
PD6	B11	B6	122	87	-	I/O	5VT	Default: PD6 Alternate: SPI2_MOSI, I2S2_SD, USART1_RX, EXMC_NWAIT, DCI_D10, EVENTOUT
PD7	A11	A5	123	88	-	I/O	5VT	Default: PD7 Alternate: USART1_CK, EXMC_NE0, EXMC_NCE1, EVENTOUT
PG9	C10	-	124	-	-	I/O	5VT	Default: PG9 Alternate: USART5_RX, EXMC_NE1, EXMC_NCE2, DCI_VSYNC, EVENTOUT
PG10	B10	-	125	-	-	I/O	5VT	Default: PG10 Alternate: EXMC_NCE3_0, EXMC_NE2, DCI_D2, EVENTOUT
PG11	B9	-	126	-	-	I/O	5VT	Default: PG11 Alternate: ETH_MII_TX_EN, ETH_RMII_TX_EN, EXMC_NCE3_1, DCI_D3, EVENTOUT
PG12	B8	-	127	-	-	I/O	5VT	Default: PG12 Alternate: USART5_RTS, EXMC_NE3, EVENTOUT
PG13	A8	-	128	-	-	I/O	5VT	Default: PG13 Alternate: TRACED2, USART5_CTS, ETH_MII_TXD0, ETH_RMII_TXD0, EXMC_A24, EVENTOUT
PG14	A7	-	129	-	-	I/O	5VT	Default: PG14 Alternate: TRACED3, USART5_TX, ETH_MII_TXD1, ETH_RMII_TXD1, EXMC_A25, EVENTOUT
V _{SS}	D7	-	130	-	-	P	-	Default: V _{SS}
V _{DD}	C7	-	131	-	-	P	-	Default: V _{DD}
PG15	B7	-	132	-	-	I/O	5VT	Default: PG15

Pin Name	Pins					Pin Type ⁽¹⁾	I/O ⁽²⁾ Level	Functions description
	BGA176	BGA100	LQFP144	LQFP100	LQFP64			
								Alternate:USART5_CTS,EXMC_SDNCAS,DCI_D13, EVENTOUT
PB3	A10	A8	133	89	55	I/O	5VT	Default: JTDO, PB3 Alternate:TRACESWO,TIMER1_CH1,SPI0_SCK,SPI2_SCK, I2S2_CK, USART0_RX, I2C1_SDA, EVENTOUT
PB4	A9	A7	134	90	56	I/O	5VT	Default: NJTRST, PB4 Alternate:TIMER2_CH0,SPI0_MISO,SPI2_MISO, I2S2_ADD_SD,I2C2_SDA,SDIO_D0,EVENTOUT, I2C0_TXFRAME
PB5	A6	C5	135	91	57	I/O	5VT	Default: PB5 Alternate:TIMER2_CH1,I2C0_SMBA,SPI0_MOSI,SPI2_MOSI,I2S2 _SD,CAN1_RX,USBHS_ULPI_D7,ETH_PPS_OUT, EXMC_SDCKE1, DCI_D10, EVENTOUT
PB6	B6	B5	136	92	58	I/O	5VT	Default: PB6 Alternate:TIMER3_CH0,I2C0_SCL,USART0_TX,CAN1_TX, EXMC_SDNE1, DCI_D5, EVENTOUT
PB7	B5	B4	137	93	59	I/O	5VT	Default: PB7 Alternate:TIMER3_CH1,I2C0_SDA,USART0_RX,EXMC_NL, DCI_VSYNC, EVENTOUT
BOOT0	D6	A4	138	94	60	I/O	5VT	Default: BOOT0
PB8	A5	A3	139	95	61	I/O	5VT	Default: PB8 Alternate:TIMER1_CH0, TIMER1_ETI, TIMER3_CH2, TIMER9_CH0, I2C0_SCL, CAN0_RX, ETH_MII_TXD3, SDIO_D4, DCI_D6, EVENTOUT
PB9	B4	B3	140	96	62	I/O	5VT	Default: PB9 Alternate:TIMER1_CH1, TIMER3_CH3, TIMER10_CH0, I2C0_SDA, SPI1_NSS, I2S1_WS, CAN0_TX, SDIO_D5, DCI_D7, EVENTOUT
PE0	A4	C3	141	97	-	I/O	5VT	Default: PE0 Alternate:TIMER3_ETI,EXMC_NBL0,DCI_D2,EVENTOUT
PE1	A3	A2	142	98	-	I/O	5VT	Default: PE1 Alternate:TIMER0_CH1_ON,EXMC_NBL1,DCI_D3, EVENTOUT
V _{SS}	D5	D3	-	99	63	P	-	Default: V _{SS}
PDR_ON	C6	H3	143	-	-	P	-	Default: PDR_ON
V _{DD}	C5	C4	144	100	64	P	-	Default: V _{DD}
PI4	D4	-	-	-	-	I/O	5VT	Default: PI4 Alternate:TIMER7_BRKIN,EXMC_NBL2,DCI_D5, EVENTOUT
PI5	C4	-	-	-	-	I/O	5VT	Default: PI5 Alternate:TIMER7_CH0,EXMC_NBL3,DCI_VSYNC, EVENTOUT
PI6	C3	-	-	-	-	I/O	5VT	Default: PI6

Pin Name	Pins					Pin Type ⁽¹⁾	I/O ⁽²⁾ Level	Functions description
	BGA176	BGA100	LQFP144	LQFP100	LQFP64			
								Alternate:TIMER7_CH1,EXMC_D28,DCI_D6,EVENTOUT
PI7	C2	-	-	-	-	I/O	5VT	Default: PI7 Alternate:TIMER7_CH2,EXMC_D29,DCI_D7,EVENTOUT

Notes:

1. Type: I = input, O = output, P = power.
2. I/O Level: 5VT = 5 V tolerant.

Table 3. Port A alternate functions summary

Pin Name	AF0	AF1	AF2	AF3	AF4	AF5	AF6	AF7	AF8	AF9	AF10	AF11	AF12	AF13	AF14	AF15
PA0		TIMER1_CH0 /TIMER1_ETI	TIMER4_CH0	TIMER7_ETI				USART1_CTS	UART3_TX			ETH_MII_CRS				EVENTOUT
PA1		TIMER1_CH1	TIMER4_CH1					USART1_RTS	UART3_RX			ETH_MII_RX_CLK/ETH_RMII_REF_CLK				EVENTOUT
PA2		TIMER1_CH2	TIMER4_CH2	TIMER8_CH0		I2S_CKIN		USART1_TX				ETH_MDIO				EVENTOUT
PA3		TIMER1_CH3	TIMER4_CH3	TIMER8_CH1		I2S1_MCK		USART1_RX			USBHS_ULPI_D0	ETH_MII_COL				EVENTOUT
PA4						SPI0_NSS	SPI2_NSS/I2S2_WS	USART1_CK					USBHS_SOF	DCI_HSYN_C		EVENTOUT
PA5		TIMER1_CH0 /TIMER1_ETI		TIMER7_CH0_ON		SPI0_SCK					USBHS_ULPI_CK					EVENTOUT
PA6		TIMER0_BRKIN	TIMER2_CH0	TIMER7_BRKIN		SPI0_MISO	I2S1_MCK			TIMER12_CH0			SDIO_CMD	DCI_PIXCLK		EVENTOUT
PA7		TIMER0_CH0_ON	TIMER2_CH1	TIMER7_CH0_ON		SPI0_MOSI				TIMER13_CH0		ETH_MII_RX_DV/ETH_RMII_CRS_DV	EXMC_SDNWE			EVENTOUT
PA8	CK_OUT0	TIMER0_CH0			I2C2_SCL			USART0_CK		CTC_SYNC	USBFS_SOF		SDIO_D1			EVENTOUT
PA9		TIMER0_CH1			I2C2_SMB_A	SPI1_SCK/I2S1_CK		USART0_TX					SDIO_D2	DCI_D0		EVENTOUT
PA10		TIMER0_CH2			I2C2_TXFRAME			USART0_RX			USBFS_ID			DCI_D1		EVENTOUT
PA11		TIMER0_CH3						USART0_CTS	USART5_TX	CAN0_RX	USBFS_DM					EVENTOUT
PA12		TIMER0_ETI						USART0_RTS	USART5_RX	CAN0_TX	USBFS_DP					EVENTOUT
PA13	JTMS/SWDIO															EVENTOUT
PA14	JTCK/SWCLK															EVENTOUT
PA15	JTDI	TIMER1_CH0 /TIMER1_ETI				SPI0_NSS	SPI2_NSS/I2S2_WS	USART0_TX								EVENTOUT

Table 4. Port B alternate functions summary

Pin Name	AF0	AF1	AF2	AF3	AF4	AF5	AF6	AF7	AF8	AF9	AF10	AF11	AF12	AF13	AF14	AF15
PB0		TIMER0_C H1_ON	TIMER2_C H2	TIMER7_C H1_ON				SPI2_MOSI /I2S2_SD			USBHS_U LPI_D1	ETH_MII_R XD2	SDIO_D 1			EVENTOUT
PB1		TIMER0_C H2_ON	TIMER2_C H3	TIMER7_C H2_ON							USBHS_U LPI_D2	ETH_MII_R XD3	SDIO_D 2			EVENTOUT
PB2		TIMER1_C H3						SPI2_MOSI /I2S2_SD			USBHS_U LPI_D4		SDIO_C K			EVENTOUT
PB3	JTDO/TRACESWO	TIMER1_C H1				SPI0_SCK	SPI2_SCK /I2S2_CK	USART0_R X		I2C1_SDA						EVENTOUT
PB4	NJTRST		TIMER2_C H0		I2C0_TXF RAME	SPI0_MIS O	SPI2_MIS O	I2S2_ADD_ SD		I2C2_SDA			SDIO_D 0			EVENTOUT
PB5			TIMER2_C H1		I2C0_SMB A	SPI0_MO SI	SPI2_MO SI/I2S2_S D			CAN1_RX	USBHS_U LPI_D7	ETH_PPS_ OUT	EXMC_S DCKE1	DCI_D10		EVENTOUT
PB6			TIMER3_C H0		I2C0_SCL			USART0_T X		CAN1_TX			EXMC_S DNE1	DCI_D5		EVENTOUT
PB7			TIMER3_C H1		I2C0_SDA			USART0_R X					EXMC_N L	DCI_VSY NC		EVENTOUT
PB8		TIMER1_C H0/TIMER 1_ETI	TIMER3_C H2	TIMER9_C H0	I2C0_SCL					CAN0_RX		ETH_MII_T XD3	SDIO_D 4	DCI_D6		EVENTOUT
PB9		TIMER1_C H1	TIMER3_C H3	TIMER10_ CH0	I2C0_SDA	SPI1_NSS /I2S1_WS				CAN0_TX			SDIO_D 5	DCI_D7		EVENTOUT
PB10		TIMER1_C H2			I2C1_SCL	SPI1_SCK /I2S1_CK	I2S2_MCK	USART2_T X			USBHS_U LPI_D3	ETH_MII_R X_ER	SDIO_D 7			EVENTOUT
PB11		TIMER1_C H3			I2C1_SDA	I2S_CKIN		USART2_R X			USBHS_U LPI_D4	ETH_MII_T X_EN/ETH_ RMII_TX_E N				EVENTOUT
PB12		TIMER0_B RKIN			I2C1_SMB A	SPI1_NSS /I2S1_WS		USART2_C K		CAN1_RX	USBHS_U LPI_D5	ETH_MII_T XD0/ETH_R MII_TXD0	USBHS_ ID			EVENTOUT
PB13		TIMER0_C H0_ON			I2C1_TXF RAME	SPI1_SCK /I2S1_CK		USART2_C TS		CAN1_TX	USBHS_U LPI_D6	ETH_MII_T XD1/ETH_R MII_TXD1				EVENTOUT
PB14		TIMER0_C H1_ON		TIMER7_C H1_ON		SPI1_MIS O	I2S1_ADD_ SD	USART2_R TS			TIMER11_ CH0		USBHS_ DM			EVENTOUT
PB15	RTC_REFI N	TIMER0_C H2_ON		TIMER7_C H2_ON		SPI1_MO SI/I2S1_S D					TIMER11_ CH1		USBHS_ DP			EVENTOUT

Table 5. Port C alternate functions summary

Pin Name	AF0	AF1	AF2	AF3	AF4	AF5	AF6	AF7	AF8	AF9	AF10	AF11	AF12	AF13	AF14	AF15
PC0											USBHS_U LPI_STP		EXMC_S DNWE			EVENTOUT
PC1						SPI2_MOS/I2S 2_SD		SPI1_MOS I/I2S1_SD				ETH_MD C				EVENTOUT
PC2						SPI1_MISO	I2S1_ADD _SD				USBHS_U LPI_DIR	ETH_MII_ TXD2	EXMC_S DNE0			EVENTOUT
PC3						SPI1_MOS/I2S 1_SD					USBHS_U LPI_NXT	ETH_MII_ TX_CLK	EXMC_S DCKE0			EVENTOUT
PC4												ETH_MII_ RXD0/ET H_RMII_R XD0	EXMC_S DNE0			EVENTOUT
PC5								USART2_ RX				ETH_MII_ RXD1/ET H_RMII_R XD1	EXMC_S DCKE0			EVENTOUT
PC6			TIMER2_ CH0	TIMER7_ CH0		I2S1_MCK			USART5_TX				SDIO_D6	DCI_D0		EVENTOUT
PC7			TIMER2_ CH1	TIMER7_ CH1		SPI1_SCK/I2S1 _CK	I2S2_MC K		USART5_RX				SDIO_D7	DCI_D1		EVENTOUT
PC8	TRACED0		TIMER2_ CH2	TIMER7_ CH2					USART5_CK				SDIO_D0	DCI_D2		EVENTOUT
PC9	CK_OUT1		TIMER2_ CH3	TIMER7_ CH3	I2C2_SD A	I2S_CKIN							SDIO_D1	DCI_D3		EVENTOUT
PC10							SPI2_SC K/I2S2_C K	USART2_ TX	UART3_TX				SDIO_D2	DCI_D8		EVENTOUT
PC11						I2S2_ADD_SD	SPI2_MIS O	USART2_ RX	UART3_RX				SDIO_D3	DCI_D4		EVENTOUT
PC12					I2C1_SD A		SPI2_MO SI/I2S2_S D	USART2_ CK	UART4_TX				SDIO_CK	DCI_D9		EVENTOUT
PC13																EVENTOUT
PC14																EVENTOUT
PC15																EVENTOUT

Table 6. Port D alternate functions summary

Pin Name	AF0	AF1	AF2	AF3	AF4	AF5	AF6	AF7	AF8	AF9	AF10	AF11	AF12	AF13	AF14	AF15
PD0							SPI2_MOS I/I2S2_SD			CAN0_R X			EXMC_D2			EVENTOUT
PD1								SPI1_NSS /I2S1_WS		CAN0_T X			EXMC_D3			EVENTOUT
PD2			TIMER2_ETI						UART4_RX				SDIO_CMD	DCI_D11		EVENTOUT
PD3	TRACED1						SPI1_SCK/ I2S1_CK	USART1_ CTS					EXMC_CLK	DCI_D5		EVENTOUT
PD4								USART1_ RTS					EXMC_NOE			EVENTOUT
PD5								USART1_ TX					EXMC_NWE			EVENTOUT
PD6							SPI2_MOSI /I2S2_SD	USART1_ RX					EXMC_NWAI T	DCI_D10		EVENTOUT
PD7								USART1_ CK					EXMC_NE0/ EXMC_NCE1			EVENTOUT
PD8								USART2_ TX					EXMC_D13			EVENTOUT
PD9								USART2_ RX					EXMC_D14			EVENTOUT
PD10								USART2_ CK					EXMC_D15			EVENTOUT
PD11								USART2_ CTS					EXMC_A16			EVENTOUT
PD12			TIMER3_CH0					USART2_ RTS					EXMC_A17			EVENTOUT
PD13			TIMER3_CH1										EXMC_A18			EVENTOUT
PD14			TIMER3_CH2										EXMC_D0			EVENTOUT
PD15	CTC_SYN C		TIMER3_CH3										EXMC_D1			EVENTOUT

Table 7. Port E alternate functions summary

Pin Name	AF0	AF1	AF2	AF3	AF4	AF5	AF6	AF7	AF8	AF9	AF10	AF11	AF12	AF13	AF14	AF15
PE0			TIMER3_ETI										EXMC_NBL0	DCI_D2		EVENTOUT
PE1		TIMER0_CH1_ON											EXMC_NBL1	DCI_D3		EVENTOUT
PE2	TRACECLK											ETH_MII_TXD3	EXMC_A23			EVENTOUT
PE3	TRACED0												EXMC_A19			EVENTOUT
PE4	TRACED1												EXMC_A20	DCI_D4		EVENTOUT
PE5	TRACED2			TIMER8_CH0									EXMC_A21	DCI_D6		EVENTOUT
PE6	TRACED3			TIMER8_CH1									EXMC_A22	DCI_D7		EVENTOUT
PE7		TIMER0_ETI											EXMC_D4			EVENTOUT
PE8		TIMER0_CH0_ON											EXMC_D5			EVENTOUT
PE9		TIMER0_CH0											EXMC_D6			EVENTOUT
PE10		TIMER0_CH1_ON											EXMC_D7			EVENTOUT
PE11		TIMER0_CH1											EXMC_D8			EVENTOUT
PE12		TIMER0_CH2_ON											EXMC_D9			EVENTOUT
PE13		TIMER0_CH2											EXMC_D10			EVENTOUT
PE14		TIMER0_CH3											EXMC_D11			EVENTOUT
PE15		TIMER0_BRKIN											EXMC_D12			EVENTOUT

Table 8. Port F alternate functions summary

Pin Name	AF0	AF1	AF2	AF3	AF4	AF5	AF6	AF7	AF8	AF9	AF10	AF11	AF12	AF13	AF14	AF15
PF0	CTC_SYN C				I2C1_SDA								EXMC_A0			EVENTOUT
PF1					I2C1_SCL								EXMC_A1			EVENTOUT
PF2					I2C1_SMB A								EXMC_A2			EVENTOUT
PF3					I2C1_TXF RAME								EXMC_A3			EVENTOUT
PF4													EXMC_A4			EVENTOUT
PF5													EXMC_A5			EVENTOUT
PF6				TIMER9_C H0									EXMC_NIORD			EVENTOUT
PF7				TIMER10_ CH0									EXMC_NREG			EVENTOUT
PF8										TIMER12_ CH0			EXMC_NIOWR			EVENTOUT
PF9										TIMER13_ CH0			EXMC_CD			EVENTOUT
PF10													EXMC_INTR	DCI_D11		EVENTOUT
PF11													EXMC_SDNRAS	DCI_D12		EVENTOUT
PF12													EXMC_A6			EVENTOUT
PF13													EXMC_A7			EVENTOUT
PF14													EXMC_A8			EVENTOUT
PF15													EXMC_A9			EVENTOUT

Table 9. Port G alternate functions summary

Pin Name	AF0	AF1	AF2	AF3	AF4	AF5	AF6	AF7	AF8	AF9	AF10	AF11	AF12	AF13	AF14	AF15
PG0													EXMC_A10			EVENTOUT
PG1													EXMC_A11			EVENTOUT
PG2													EXMC_A12			EVENTOUT
PG3													EXMC_A13			EVENTOUT
PG4													EXMC_A14			EVENTOUT
PG5													EXMC_A15			EVENTOUT
PG6													EXMC_INT 1	DCI_D12		EVENTOUT
PG7									USART5_ CK				EXMC_INT 2	DCI_D13		EVENTOUT
PG8									USART5_ RTS			ETH_PPS_ OUT	EXMC_SD CLK			EVENTOUT
PG9									USART5_ RX				EXMC_NE 1/EXMC_N CE2	DCI_VSY NC		EVENTOUT
PG10													EXMC_NC E3_0/EXM C_NE2	DCI_D2		EVENTOUT
PG11												ETH_MII_T X_EN/ETH _RMII_TX_ EN	EXMC_NC E3_1	DCI_D3		EVENTOUT
PG12									USART5_ RTS				EXMC_NE 3			EVENTOUT
PG13	TRACED2								USART5_ CTS			ETH_MII_T XD0/ETH_ RMII_TXD0	EXMC_A24			EVENTOUT
PG14	TRACED3								USART5_ TX			ETH_MII_T XD1/ETH_ RMII_TXD1	EXMC_A25			EVENTOUT
PG15									USART5_ CTS				EXMC_SD NCAS	DCI_D13		EVENTOUT

Table 10. Port H alternate functions summary

Pin Name	AF0	AF1	AF2	AF3	AF4	AF5	AF6	AF7	AF8	AF9	AF10	AF11	AF12	AF13	AF14	AF15
PH0																EVENTOUT
PH1																EVENTOUT
PH2												ETH_MII_CRS	EXMC_SDCKE0			EVENTOUT
PH3					I2C1_TXFRAME							ETH_MII_COL	EXMC_SDN E0			EVENTOUT
PH4					I2C1_SCL						USBHS_ULPI_NXT					EVENTOUT
PH5					I2C1_SDA								EXMC_SDN WE			EVENTOUT
PH6					I2C1_SMBA					TIMER11_CH0		ETH_MII_RXD2	EXMC_SDN E1	DCI_D8		EVENTOUT
PH7					I2C2_SCL							ETH_MII_RXD3	EXMC_SDCKE1	DCI_D9		EVENTOUT
PH8					I2C2_SDA								EXMC_D16	DCI_HSYNC		EVENTOUT
PH9					I2C2_SMBA					TIMER11_CH1			EXMC_D17	DCI_D0		EVENTOUT
PH10			TIMER4_CH0		I2C2_TXFRAME								EXMC_D18	DCI_D1		EVENTOUT
PH11			TIMER4_CH1										EXMC_D19	DCI_D2		EVENTOUT
PH12			TIMER4_CH2										EXMC_D20	DCI_D3		EVENTOUT
PH13				TIMER7_CH0_ON						CAN0_TX			EXMC_D21			EVENTOUT
PH14				TIMER7_CH1_ON									EXMC_D22	DCI_D4		EVENTOUT
PH15				TIMER7_CH2_ON									EXMC_D23	DCI_D11		EVENTOUT

Table 11. Port I alternate functions summary

Pin Name	AF0	AF1	AF2	AF3	AF4	AF5	AF6	AF7	AF8	AF9	AF10	AF11	AF12	AF13	AF14	AF15
PI0			TIMER4_C H3			SPI1_NSS/ 2S1_WS							EXMC_D24	DCI_D13		EVENTOUT
PI1						SPI1_SCK/ 2S1_CK							EXMC_D25	DCI_D8		EVENTOUT
PI2				TIMER7_CH3		SPI1_MISO	I2S1_ADD _SD						EXMC_D26	DCI_D9		EVENTOUT
PI3				TIMER7_ETI		SPI1_MOSI /I2S1_SD							EXMC_D27	DCI_D10		EVENTOUT
PI4				TIMER7_BRKI N									EXMC_NB L2	DCI_D5		EVENTOUT
PI5				TIMER7_CH0									EXMC_NB L3	DCI_VSY NC		EVENTOUT
PI6				TIMER7_CH1									EXMC_D28	DCI_D6		EVENTOUT
PI7				TIMER7_CH2									EXMC_D29	DCI_D7		EVENTOUT
PI8																EVENTOUT
PI9										CAN0_RX			EXMC_D30			EVENTOUT
PI10												ETH_MII_ RX_ER	EXMC_D31			EVENTOUT
PI11											USBHS_U LPI_DIR					EVENTOUT

3 Functional description

3.1 ARM® Cortex®-M4 core

The ARM® Cortex®-M4 processor is a high performance embedded processor with DSP instructions which allow efficient signal processing and complex algorithm execution. It brings an efficient, easy-to-use blend of control and signal processing capabilities to meet the digital signal control markets demand. The processor is highly configurable enabling a wide range of implementations from those requiring floating point operations, memory protection and powerful trace technology to cost sensitive devices requiring minimal area, while delivering outstanding computational performance and an advanced system response to interrupts.

32-bit ARM® Cortex®-M4 processor core

- Up to 168 MHz operation frequency
- Single-cycle multiplication and hardware divider
- Floating Point Unit (FPU)
- Integrated DSP instructions
- Integrated Nested Vectored Interrupt Controller (NVIC)
- 24-bit SysTick timer

The Cortex®-M4 processor is based on the ARMv7-M architecture and supports both Thumb and Thumb-2 instruction sets. Some system peripherals listed below are also provided by Cortex®-M4:

- Internal Bus Matrix connected with ICode bus, DCode bus, system bus, Private Peripheral Bus (PPB) and debug accesses (AHB-AP)
- Nested Vectored Interrupt Controller (NVIC)
- Flash Patch and Breakpoint (FPB)
- Data Watchpoint and Trace (DWT)
- Instrument Trace Macrocell (ITM)
- Memory Protection Unit (MPU)
- Serial Wire JTAG Debug Port (SWJ-DP)
- Trace Port Interface Unit (TPIU)

3.2 On-chip memory

- Up to 3072 Kbytes of Flash memory, including code Flash and data Flash
- 512B of OTP (one-time programmable) memory
- 192 KB of SRAM

The ARM® Cortex®-M4 processor is structured in Harvard architecture which can use separate buses to fetch instructions and load/store data. 3072 Kbytes of inner Flash at most, which includes code Flash and data Flash is available for storing programs and data, and

accessed (R/W) at CPU clock speed with zero wait states. Up to 192 Kbytes of inner SRAM is composed of SRAM0 (112KB) and SRAM1 (16KB) that can be accessed at same time, and including 64 KB of TCM (tightly-coupled memory) data RAM that can be accessed only by the data bus of the Cortex®-M4 core. The additional 4KB of backup SRAM (BKP SRAM) is implemented in the backup domain, which can keep its content even when the V_{DD} power supply is down. The Figure of GD32F407xx memory map shows the memory map of the GD32F407xx series of devices, including Flash, SRAM, peripheral, and other pre-defined regions.

3.3 Clock, reset and supply management

- Internal 16 MHz factory-trimmed RC and external 4 to 32 MHz crystal oscillator
- Internal 48 MHz RC oscillator
- Internal 32 KHz RC calibrated oscillator and external 32.768 KHz crystal oscillator
- Integrated system clock PLL
- 2.6 to 3.6 V application supply and I/Os
- Supply Supervisor: POR (Power On Reset), PDR (Power Down Reset), and low voltage detector (LVD)

The Clock Control Unit (CCU) provides a range of oscillator and clock functions. These include internal RC oscillator and external crystal oscillator, high speed and low speed two types. Several prescalers allow the frequency configuration of the AHB and two APB domains. The maximum frequency of the two AHB domains are 168 MHz. The maximum frequency of the two APB domains including APB1 is 42 MHz and APB2 is 84 MHz. See Figure 6 for details on the clock tree.

The Reset Control Unit (RCU) controls three kinds of reset: system reset resets the processor core and peripheral IP components. Power-on reset (POR) and power-down reset (PDR) are always active, and ensures proper operation starting from 2.4 V and down to 1.8V. The device remains in reset mode when V_{DD} is below a specified threshold. The embedded low voltage detector (LVD) monitors the power supply, compares it to the voltage threshold and generates an interrupt as a warning message for leading the MCU into security.

Power supply schemes:

- V_{DD} range: 2.6 to 3.6 V, external power supply for I/Os and the internal regulator. Provided externally through V_{DD} pins.
- V_{SSA} , V_{DDA} range: 2.6 to 3.6 V, external analog power supplies for ADC, reset blocks, RCs and PLL. V_{DDA} and V_{SSA} must be connected to V_{DD} and V_{SS} , respectively.
- V_{BAT} range: 1.8 to 3.6 V, power supply for RTC, external clock 32 kHz oscillator and backup registers (through power switch) when V_{DD} is not present.

3.4 Boot modes

At startup, boot pins are used to select one of three boot options:

- Boot from main Flash memory (default)
- Boot from system memory
- Boot from on-chip SRAM

The boot loader is located in the internal 30KB of information blocks for the boot ROM memory (system memory). It is used to reprogram the Flash memory by using USART0, USART2, and USB Device FS in device mode. It also can be used to transfer and update the Flash memory code, the data and the vector table sections. In default condition, boot from bank 0 of Flash memory is selected. It also supports to boot from bank 2 of Flash memory by setting a bit in option bytes.

3.5 Power saving modes

The MCU supports three kinds of power saving modes to achieve even lower power consumption. They are Sleep mode, Deep-sleep mode, and Standby mode. These operating modes reduce the power consumption and allow the application to achieve the best balance between the CPU operating time, speed and power consumption.

- **Sleep mode**

In sleep mode, only the clock of CPU core is off. All peripherals continue to operate and any interrupt/event can wake up the system.

- **Deep-sleep mode**

In Deep-sleep mode, all clocks in the 1.2V domain are off, and all of the high speed crystal oscillator (IRC16M, HXTAL) and PLL are disabled. Only the contents of SRAM and registers are retained. Any interrupt or wakeup event from EXTI lines can wake up the system from the Deep-sleep mode including the 23 external lines, the RTC alarm, the LVD output, and USB wakeup. When exiting the Deep-sleep mode, the IRC16M is selected as the system clock.

- **Standby mode**

In Standby mode, the whole 1.2V domain is power off, the LDO is shut down, and all of IRC16M, HXTAL and PLL are disabled. The contents of SRAM and registers (except Backup Registers) are lost. There are four wakeup sources for the Standby mode, including the external reset from NRST pin, the RTC, the FWDG reset, and the rising edge on WKUP pin.

3.6 Analog to digital converter (ADC)

- 12-bit SAR ADC's conversion rate is up to 2.6MSPS
- 12-bit, 10-bit, 8-bit or 6-bit configurable resolution
- Hardware oversampling ratio adjustable from 2 to 256x improves resolution to 16-bit
- Input voltage range: V_{SSA} to V_{DDA} (2.6 to 3.6 V)
- Temperature sensor

Up to three 12-bit 2.6MSPS multi-channel ADCs are integrated in the device. It has a total of 19 multiplexed channels: 16 external channels, 1 channel for internal temperature sensor (V_{SENSE}), 1 channel for internal reference voltage (V_{REFINT}) and 1 channel for external battery power supply (V_{BAT}). The input voltage range is between 2.6 V and 3.6 V. An on-chip hardware oversampling scheme improves performance while off-loading the related computational burden from the CPU. An analog watchdog block can be used to detect the channels, which are required to remain within a specific threshold window. A configurable channel management block can be used to perform conversions in single, continuous, scan or discontinuous mode to support more advanced use.

The ADC can be triggered from the events generated by the general-purpose level 0 timers (TMx) and the advanced-control timers (TM0 and TM7) with internal connection. The temperature sensor can be used to generate a voltage that varies linearly with temperature. It is internally connected to the ADC_IN16 input channel which is used to convert the sensor output voltage in a digital value.

3.7 Digital to analog converter (DAC)

- Two 12-bit DAC converter of independent output channel
- 8-bit or 12-bit mode in conjunction with the DMA controller

The 12-bit buffered DAC channel is used to generate variable analog outputs. The DACs are designed with integrated resistor strings structure. The DAC channels can be triggered by the timer update outputs or EXTI with DMA support. The maximum output value of the DAC is V_{REF+} .

3.8 DMA

- 16 channels DMA controller and each channel are configurable (8 for DMA0 and 8 for DMA1)
- Support independent 8, 16, 32-bit memory and peripheral transfer
- Peripherals supported: Timers, ADC, SPIs, I2Cs, USARTs, DAC, I2S, SDIO and DCI

The flexible general-purpose DMA controllers provide a hardware method of transferring data between peripherals and/or memory without intervention from the CPU, thereby freeing up bandwidth for other system functions. Three types of access method are supported: peripheral to memory, memory to peripheral, memory to memory

Each channel is connected to fixed hardware DMA requests. The priorities of DMA channel requests are determined by software configuration and hardware channel number. Transfer size of source and destination are independent and configurable.

3.9 General-purpose inputs/outputs (GPIOs)

- Up to 140 fast GPIOs, all mappable on 16 external interrupt vectors (EXTI)
- Analog input/output configurable
- Alternate function input/output configurable

There are up to 140 general purpose I/O pins (GPIO) in GD32F407xx, named PA0 ~ PA15, PB0 ~ PB15, PC0 ~ PC15, PD0 ~ PD15, PE0 ~ PE15, PF0 ~ PF15, PG0 ~ PG15, PH0 ~ PH15 and PI0 ~ PI11 to implement logic input/output functions. Each of the GPIO ports has related control and configuration registers to satisfy the requirements of specific applications. The external interrupts on the GPIO pins of the device have related control and configuration registers in the External Interrupt Control Unit (EXTI). The GPIO ports are pin-shared with other alternative functions (AFs) to obtain maximum flexibility on the package pins. Each of the GPIO pins can be configured by software as output (push-pull or open-drain), as input (with or without pull-up or pull-down) or as peripheral alternate function. Most of the GPIO pins are shared with digital or analog alternate functions. All GPIOs are high-current capable except for analog inputs.

3.10 Timers and PWM generation

- Two 16-bit advanced-control timer (TM0 & TM7), eight 16-bit general-purpose timers (TM2, TM3, TM8 ~ TM13), two 32-bit general-purpose timers (TM1 & TM4) and two 16-bit basic timer (TM5 & TM6)
- Up to 4 independent channels of PWM, output compare or input capture for each general-purpose timer (GPTM) and external trigger input
- 16-bit, motor control PWM advanced-control timer with programmable dead-time generation for output match
- Encoder interface controller with two inputs using quadrature decoder
- 24-bit SysTick timer down counter
- 2 watchdog timers (Free watchdog and window watchdog)

The advanced-control timer (TM0 & TM7) can be used as a three-phase PWM multiplexed on 6 channels. It has complementary PWM outputs with programmable dead-time generation. It can also be used as a complete general-purpose timer. The 4 independent channels can be used for input capture, output compare, PWM generation (edge- or center-aligned counting modes) and single pulse mode output. If configured as a general-purpose 16-bit timer, it has the same functions as the TMx timer. It can be synchronized with external signals or to interconnect with other GPTMs together which have the same architecture and features.

The general-purpose timer (GPTM), can be used for a variety of purposes including general time, input signal pulse width measurement or output waveform generation such as a single pulse generation or PWM output, up to 4 independent channels for input capture/output compare. TM1 & TM4 is based on a 32-bit auto-reload up/downcounter and a 16-bit prescaler. TM2 & TM3 is based on a 16-bit auto-reload up/downcounter and a 16-bit prescaler. TM9 ~ TM13 is based on a 16-bit auto-reload upcounter and a 16-bit prescaler. The GPTM also supports an encoder interface with two inputs using quadrature decoder.

The basic timer, known as TM5 & TM6, are mainly used for DAC trigger generation. They can also be used as a simple 16-bit time base.

The GD32F407xx have two watchdog peripherals, free watchdog and window watchdog. They offer a combination of high safety level, flexibility of use and timing accuracy.

The free watchdog timer includes a 12-bit down-counting counter and a 8-bit prescaler, It is clocked from an independent 32 kHz internal RC and as it operates independently of the main clock, it can operate in deep sleep and standby modes. It can be used either as a watchdog to reset the device when a problem occurs, or as a free-running timer for application timeout management.

The window watchdog is based on a 7-bit down counter that can be set as free-running. It can be used as a watchdog to reset the device when a problem occurs. It is clocked from the main clock. It has an early warning interrupt capability and the counter can be frozen in debug mode.

The SysTick timer is dedicated for OS, but could also be used as a standard down counter. It features:

- A 24-bit down counter
- Auto reload capability
- Maskable system interrupt generation when the counter reaches 0
- Programmable clock source

3.11 Real time clock (RTC) and backup registers

- Independent binary-coded decimal (BCD) format timer/counter with twenty 32-bit backup registers.
- Calendar with subsecond, seconds, minutes, hours, week day, date, year and month automatically correction
- Alarm function with wake up from deep-sleep and standby mode capability
- On-the-fly correction for synchronization with master clock. Digital calibration with 1 ppm resolution for compensation of quartz crystal inaccuracy.

The real time clock is an independent timer which provides a set of continuously running counters in backup registers to provide a real calendar function, and provides an alarm interrupt or an expected interrupt. It is not reset by a system or power reset, or when the device wakes up from standby mode. A prescaler is used for the time base clock and is by default configured to generate a time base of 1 second from a clock at 32.768 kHz from external crystal oscillator.

3.12 Inter-integrated circuit (I2C)

- Up to three I2C bus interfaces can support both master and slave mode with a frequency up to 400 kHz (Fast mode)
- Provide arbitration function, optional PEC (packet error checking) generation and checking
- Supports 7-bit and 10-bit addressing mode and general call addressing mode

The I2C interface is an internal circuit allowing communication with an external I2C interface which is an industry standard two line serial interface used for connection to external hardware. These two serial lines are known as a serial data line (SDA) and a serial clock line (SCL). The I2C module provides two data transfer rates: 100 kHz of standard mode or 400 kHz of the fast mode. The I2C module also has an arbitration detect function to prevent the situation where more than one master attempts to transmit data to the I2C bus at the same time. A CRC-8 calculator is also provided in I2C interface to perform packet error checking for I2C data.

3.13 Serial peripheral interface (SPI)

- Up to three SPI interfaces with a frequency of up to 30 MHz
- Support both master and slave mode
- Hardware CRC calculation and transmit automatic CRC error checking

The SPI interface uses 4 pins, among which are the serial data input and output lines (MISO & MOSI), the clock line (SCK) and the slave select line (NSS). Both SPIs can be served by the DMA controller. The SPI interface may be used for a variety of purposes, including simplex synchronous transfers on two lines with a possible bidirectional data line or reliable communication using CRC checking.

3.14 Universal synchronous/asynchronous receiver transmitter (USART/UART)

- Up to four USARTs and two UARTs with operating frequency up to 9 MHz
- Supports both asynchronous and clocked synchronous serial communication modes
- IrDA SIR encoder and decoder support
- LIN break generation and detection
- ISO 7816-3 compliant smart card interface

The USART (USART0, USART1, USART2, USART5) and UART (UART3, UART4) are used to translate data between parallel and serial interfaces, provides a flexible full duplex data exchange using synchronous or asynchronous transfer. It is also commonly used for RS-232 standard communication. The USART/UART includes a programmable baud rate generator which is capable of dividing the system clock to produce a dedicated clock for the USART/UART transmitter and receiver. The USART/UART also supports DMA function for high speed data communication.

3.15 Inter-IC sound (I2S)

- Two I2S bus Interfaces with sampling frequency from 8 kHz to 192 kHz, multiplexed with SPI1 and SPI2
- Support either master or slave mode Audio
- Sampling frequencies from 8 kHz up to 192 kHz are supported.

The Inter-IC sound (I2S) bus provides a standard communication interface for digital audio applications by 4-wire serial lines. GD32F407xx contain an I2S-bus interface that can be operated with 16/32 bit resolution in master or slave mode, pin multiplexed with SPI1 and SPI2. The audio sampling frequencies from 8 kHz to 192 kHz is supported.

3.16 Universal serial bus on-the-go full-speed (USB OTG FS)

- One USB device/host/OTG full-speed Interface with frequency up to 12 Mbit/s
- Internal 48 MHz oscillator support crystal-less operation
- Internal main PLL for USB CLK compliantly
- Internal USB OTG FS PHY support

The Universal Serial Bus (USB) is a 4-wire bus with 4 bidirectional endpoints. The device controller enables 12 Mbit/s data exchange with integrated transceivers in device/host/OTG mode. Full-speed peripheral is compliant with the USB 2.0 specification. Transaction formatting is performed by the hardware, including CRC generation and checking. The status of a completed USB transfer or error condition is indicated by status registers. An interrupt is also generated if enabled. The required precise 48 MHz clock which can be generated from the internal main PLL (the clock source must use an HXTAL crystal oscillator) or by the internal 48 MHz oscillator in automatic trimming mode that allows crystal-less operation.

3.17 Universal serial bus on-the-go high-speed (USB OTG HS)

- One USB device/host/OTG high-speed Interface with frequency up to 480 Mbit/s
- An external PHY device connected to the ULPI is required when using in HS mode

USB OTG HS supports both host and device modes, as well as OTG mode with Host Negotiation Protocol (HNP) and Session Request Protocol (SRP). The controller provides ULPI interface for external USB PHY integration and it also contains a full-speed USB PHY internal. For full-speed or low-speed operation, no more external PHY chip is needed. It supports all the four types of transfer (control, bulk, Interrupt and isochronous) defined in USB 2.0 protocol. HUB connection is supported when USB HS operates at high-speed in host mode. There is also a DMA engine operating as an AHB bus master in USBHS to speed up the data transfer between USB HS and system.

3.18 Controller area network (CAN)

- Two CAN2.0B interface with communication frequency up to 1 Mbit/s
- Internal main PLL for CAN CLK compliantly

Controller area network (CAN) is a method for enabling serial communication in field bus. The CAN protocol has been used extensively in industrial automation and automotive applications. It can receive and transmit standard frames with 11-bit identifiers as well as extended frames with 29-bit identifiers. Each CAN has three mailboxes for transmission and two FIFOs of three message deep for reception. It also provides 28 scalable/configurable identifier filter banks for selecting the incoming messages needed and discarding the others.

3.19 Ethernet MAC interface

- IEEE 802.3 compliant media access controller (MAC) for Ethernet LAN
- 10/100 Mbit/s rates with dedicated DMA controller and SRAM
- Support hardware precision time protocol (PTP) with conformity to IEEE 1588

The Ethernet media access controller (MAC) conforms to IEEE 802.3 specifications and fully supports IEEE 1588 standards. The embedded MAC provides the interface to the required external network physical interface (PHY) for LAN bus connection via an internal media independent interface (MII) or a reduced media independent interface (RMII). The number of MII signals provided up to 16 with 25 MHz output and RMII up to 7 with 50 MHz output. The function of 32-bit CRC checking is also available.

3.20 External memory controller (EXMC)

- Supported external memory: SRAM, PSRAM, ROM and NOR-Flash, NAND Flash and CF card, SDRAM with up to 32-bit data bus
- Provide ECC calculating hardware module for NAND Flash memory block
- Two SDRAM banks with independent configuration, up to 13-bits Row Address, 11-bits Column Address, 2-bits internal banks address
- SDRAM Memory size: 4x16Mx32bit (256 MB), 4x16Mx16bit (128 MB), 4x16Mx8bit (64 MB)

External memory controller (EXMC) is an abbreviation of external memory controller. It is divided in to several sub-banks for external device support, each sub-bank has its own chip selection signal but at one time, only one bank can be accessed. The EXMC support code execution from external memory except NAND Flash and CF card. The EXMC also can be configured to interface with the most common LCD module of Motorola 6800 and Intel 8080 series and reduce the system cost and complexity.

The EXMC of GD32F407xx in LQFP144 & BGA176 package also supports synchronous dynamic random access memory (SDRAM). It translates AHB transactions into the appropriate SDRAM protocol, and meanwhile, makes sure the access time requirements of the external SDRAM devices are satisfied.

3.21 Secure digital input and output card interface (SDIO)

- Support SD2.0/SDIO2.0/MMC4.2 host interface

The Secure Digital Input and Output Card Interface (SDIO) provides access to external SD memory cards specifications version 2.0, SDIO card specification version 2.0 and multi-media card system specification version 4.2 with DMA supported. In addition, this interface is also compliant with CE-ATA digital protocol rev1.1.

3.22 Digital camera interface (DCI)

- Digital video/picture capture
- 8/10/12/14 data width supported
- High transfer efficiency with DMA interface
- Video/picture crop supported
- Various pixel formats supported including JPEG/YCrCb/RGB
- Hard/embedded synchronous signals supported

DCI is an 8-bit to 14-bit parallel interface that able to capture video or picture from a camera via Digital Camera Interface. It supports 8/10/12/14 bits data width through DMA operation.

3.23 Debug mode

- Serial wire JTAG debug port (SWJ-DP)

The ARM® SWJ-DP Interface is embedded and is a combined JTAG and serial wire debug port that enables either a serial wire debug or a JTAG probe to be connected to the target.

3.24 Package and operation temperature

- BGA176 (GD32F407Ix), BGA100 (GDF407VxH), LQFP144 (GD32F407Zx), LQFP100 (GD32F407Vx) and LQFP64 (GD32F407Rx)
- Operation temperature range: -40°C to +85°C (industrial level)

4 Electrical characteristics

4.1 Absolute maximum ratings

The maximum ratings are the limits to which the device can be subjected without permanently damaging the device. Note that the device is not guaranteed to operate properly at the maximum ratings. Exposure to the absolute maximum rating conditions for extended periods may affect device reliability.

Table 12. Absolute maximum ratings

Symbol	Parameter	Min	Max	Unit
V _{DD}	External voltage range	V _{SS} - 0.3	V _{SS} + 3.6	V
V _{DDA}	External analog supply voltage	V _{SSA} - 0.3	V _{SSA} + 3.6	V
V _{BAT}	External battery supply voltage	V _{SS} - 0.3	V _{SS} + 3.6	V
V _{IN}	Input voltage on 5V tolerant pin	V _{SS} - 0.3	V _{SS} + 4.0	V
	Input voltage on other I/O	V _{SS} - 0.3	4.0	V
I _{IO}	Maximum current for GPIO pins	—	25	mA
T _A	Operating temperature range	-40	+85	°C
T _{STG}	Storage temperature range	-55	+150	°C
T _J	Maximum junction temperature	—	125	°C

4.2 Recommended DC characteristics

Table 13. DC operating conditions

Symbol	Parameter	Conditions	Min	Typ	Max	Unit
V _{DD}	Supply voltage	—	2.6	3.3	3.6	V
V _{DDA}	Analog supply voltage	Same as V _{DD}	2.6	3.3	3.6	V
V _{BAT}	Battery supply voltage	—	1.8	—	3.6	V

4.3 Power consumption

The power measurements specified in the tables represent that code with data executing from on-chip Flash with the following specifications.

Table 14. Power consumption characteristics

Symbol	Parameter	Conditions	Min	Typ	Max	Unit
I _{DD}	Supply current (Run mode)	V _{DD} =V _{DDA} =3.3V, HXTAL=25MHz, System clock=168MHz, All peripherals enabled	—	99.2	—	mA
		V _{DD} =V _{DDA} =3.3V, HXTAL =25MHz, System clock =168MHz, All peripherals disabled	—	60.1	—	mA
		V _{DD} =V _{DDA} =3.3V, HXTAL =25MHz, System clock =108MHz, All peripherals enabled	—	56.3	—	mA
		V _{DD} =V _{DDA} =3.3V, HXTAL =25MHz, System Clock =108MHz, All peripherals disabled	—	35.2	—	mA
	Supply current (Sleep mode)	V _{DD} =V _{DDA} =3.3V, HXTAL =25MHz, CPU clock off, System clock=168MHz, All peripherals enabled	—	67.9	—	mA
		V _{DD} =V _{DDA} =3.3V, HXTAL =25MHz, CPU clock off, System clock=168MHz, All peripherals disabled	—	30	—	mA
	Supply current (Deep-Sleep mode)	V _{DD} =V _{DDA} =3.3V, Regulator in run mode, IRC32K on, RTC on, All GPIOs analog mode	—	1.57	—	mA
		V _{DD} =V _{DDA} =3.3V, Regulator in low power mode, IRC32K on, RTC on, All GPIOs analog mode	—	1.55	—	mA
	Supply current (Standby mode)	V _{DD} =V _{DDA} =3.3V, LXTAL off, IRC32K on, RTC on	—	5.36	—	μA
		V _{DD} =V _{DDA} =3.3V, LXTAL off, IRC32K on, RTC off	—	5.03	—	μA
		V _{DD} =V _{DDA} =3.3V, LXTAL off, IRC32K off, RTC off	—	4.45	—	μA
	I _{BAT}	Battery supply current	V _{DD} not available, V _{BAT} =3.6 V, LXTAL on with external crystal, RTC on, Higher driving	—	2.03	—
V _{DD} not available, V _{BAT} =3.3 V, LXTAL on with external crystal, RTC on, Higher driving			—	1.73	—	μA
V _{DD} not available, V _{BAT} =2.6 V, LXTAL on with external crystal, RTC on, Higher driving			—	1.43	—	μA
V _{DD} not available, V _{BAT} =3.6 V, LXTAL on with external crystal, RTC on, Lower driving			—	1.43	—	μA

Symbol	Parameter	Conditions	Min	Typ	Max	Unit
		V _{DD} not available, V _{BAT} =3.3 V, LXTAL on with external crystal, RTC on, Lower driving	—	1.15	—	μA
		V _{DD} not available, V _{BAT} =2.6 V, LXTAL on with external crystal, RTC on, Lower driving	—	0.83	—	μA

4.4 EMC characteristics

EMS (electromagnetic susceptibility) includes ESD (Electrostatic discharge, positive and negative) and FTB (Burst of Fast Transient voltage, positive and negative) testing result is given in the following table, based on the EMS levels and classes compliant with IEC 61000 series standard.

Table 15. EMS characteristics

Symbol	Parameter	Conditions	Level/Class
V _{ESD}	Voltage applied to all device pins to induce a functional disturbance	VDD = 3.3 V, TA = +25 °C conforms to IEC 61000-4-2	3B
V _{FTB}	Fast transient voltage burst applied to induce a functional disturbance through 100 pF on V _{DD} and V _{SS} pins	VDD = 3.3 V, TA = +25 °C conforms to IEC 61000-4-4	4A

EMI (Electromagnetic Interference) emission testing result is given in the following table, compliant with IEC 61967-2 standard which specifies the test board and the pin loading.

Table 16. EMI characteristics

Symbol	Parameter	Conditions	Tested frequency band	Conditions		Unit
				24M	48M	
S _{EMI}	Peak level	VDD = 5.0 V, TA = +25 °C, compliant with IEC 61967-2	0.1 to 2 MHz	<0	<0	dBμV
			2 to 30 MHz	-3.9	-2.8	
			30 to 130 MHz	-7.2	-8	
			130 MHz to 1GHz	-7	-7	

4.5 Power supply supervisor characteristics

Table 17. Power supply supervisor characteristics

Symbol	Parameter	Conditions	Min	Typ	Max	Unit
V _{POR}	Power on reset threshold	—	2.30	2.40	2.48	V
V _{PDR}	Power down reset threshold		1.72	1.80	1.88	V
V _{HYST}	PDR hysteresis		—	0.05	—	V
T _{RSTTEMP}	Reset temporization		—	2	—	ms

4.6 Electrical sensitivity

The device is strained in order to determine its performance in terms of electrical sensitivity. Electrostatic discharges (ESD) are applied directly to the pins of the sample. Static latch-up (LU) test is based on the two measurement methods.

Table 18. ESD characteristics

Symbol	Parameter	Conditions	Min	Typ	Max	Unit
V _{ESD(HBM)}	Electrostatic discharge voltage (human body model)	T _A =25 °C; JESD22-A114	—	—	7000	V
V _{ESD(CDM)}	Electrostatic discharge voltage (charge device model)	T _A =25 °C; JESD22-C101	—	—	800	V

Table 19. Static latch-up characteristics

Symbol	Parameter	Conditions	Min	Typ	Max	Unit
LU	I-test	T _A =25 °C; JESD78	—	—	±100	mA
	V _{supply over voltage}		—	—	5.4	V

4.7 External clock characteristics

Table 20. High speed external clock (HXTAL) generated from a crystal/ceramic characteristics

Symbol	Parameter	Conditions	Min	Typ	Max	Unit
f_{HXTAL}	High Speed External oscillator (HXTAL) frequency	$V_{\text{DD}}=5.0\text{V}$	4	8	32	MHz
C_{HXTAL}	Recommended load capacitance on OSC_IN and OSC_OUT	—	—	20	30	pF
R_{FHXTAL}	Recommended external feedback resistor between OSC_IN and OSC_OUT	—	—	400	—	K Ω
D_{HXTAL}	HXTAL oscillator duty cycle	—	30	50	70	%
I_{DDHXTAL}	HXTAL oscillator operating current	$V_{\text{DD}}=3.3\text{V}$, $T_{\text{A}}=25^{\circ}\text{C}$	—	1	—	mA
t_{SUHXTAL}	HXTAL oscillator startup time	$V_{\text{DD}}=3.3\text{V}$, $T_{\text{A}}=25^{\circ}\text{C}$	—	2	—	ms

Table 21. Low speed external clock (LXTAL) generated from a crystal/ceramic characteristics

Symbol	Parameter	Conditions	Min	Typ	Max	Unit
f_{LXTAL}	Low Speed External oscillator (LXTAL) frequency	$V_{\text{DD}}=V_{\text{BAT}}=3.3\text{V}$	—	32.768	—	KHz
C_{LXTAL}	Recommended load capacitance on OSC32_IN and OSC32_OUT	—	—	—	15	pF
D_{LXTAL}	LXTAL oscillator duty cycle	—	30	50	70	%
I_{DDLXTAL}	LXTAL oscillator operating current	Low Drive	—	0.7	—	μA
		High Drive	—	1.3	—	
t_{SULXTAL}	LXTAL oscillator startup time	$V_{\text{DD}}=V_{\text{BAT}}=3.3\text{V}$	—	2	—	s

4.8 Internal clock characteristics

Table 22. High speed internal clock (IRC16M) characteristics

Symbol	Parameter	Conditions	Min	Typ	Max	Unit
f_{IRC16M}	High Speed Internal Oscillator (IRC16M) frequency	$V_{DD}=3.3V$	—	16	—	MHz
ACC_{IRC16M}	IRC16M oscillator Frequency accuracy, Factory-trimmed	$V_{DD}=3.3V, T_A=-40^{\circ}C \sim +105^{\circ}C$	-4.0	—	+5.0	%
		$V_{DD}=3.3V, T_A=0^{\circ}C \sim +85^{\circ}C$	-2.0	—	+2.0	%
		$V_{DD}=3.3V, T_A=25^{\circ}C$	-1.0	—	+1.0	%
	IRC16M oscillator Frequency accuracy, User trimming step	—	—	0.5	—	%
D_{IRC16M}	IRC16M oscillator duty cycle	$V_{DD}=3.3V, f_{IRC16M}=16MHz$	45	50	55	%
$I_{DDIRC16M}$	IRC16M oscillator operating current	$V_{DD}=3.3V, f_{IRC16M}=16MHz$	—	66	80	μA
$t_{SUIRC16M}$	IRC16M oscillator startup time	$V_{DD}=3.3V, f_{IRC16M}=16MHz$	—	2.5	4	μs

Table 23. High speed internal clock (IRC48M) characteristics

Symbol	Parameter	Conditions	Min	Typ	Max	Unit
f_{IRC48M}	High Speed Internal Oscillator (IRC48M) frequency	$V_{DD}=3.3V$	—	48	—	MHz
ACC_{IRC48M}	IRC48M oscillator Frequency accuracy, Factory-trimmed	$V_{DD}=3.3V, T_A=-40^{\circ}C \sim +105^{\circ}C$	-4.0	—	+5.0	%
		$V_{DD}=3.3V, T_A=0^{\circ}C \sim +85^{\circ}C$	-3.0	—	+3.0	%
		$V_{DD}=3.3V, T_A=25^{\circ}C$	-2.0	—	+2.0	%
	IRC48M oscillator Frequency accuracy, User trimming step	—	—	0.12	—	%
D_{IRC48M}	IRC48M oscillator duty cycle	$V_{DD}=3.3V, f_{IRC48M}=16MHz$	45	50	55	%
$I_{DDIRC48M}$	IRC48M oscillator operating current	$V_{DD}=3.3V, f_{IRC48M}=16MHz$	—	240	300	μA
$t_{SUIRC48M}$	IRC48M oscillator startup time	$V_{DD}=3.3V, f_{IRC48M}=16MHz$	—	2.5	4	μs

Table 24. Low speed internal clock (IRC32K) characteristics

Symbol	Parameter	Conditions	Min	Typ	Max	Unit
f _{IRC32K}	Low Speed Internal oscillator (IRC32K) frequency	V _{DD} =V _{BAT} =3.3V, T _A =-40°C ~ +85°C	20	32	45	KHz
I _{DDIRC32K}	IRC32K oscillator operating current	V _{DD} =V _{BAT} =3.3V, T _A =25°C	—	0.4	0.6	μA
t _{SUIRC32K}	IRC32K oscillator startup time	V _{DD} =V _{BAT} =3.3V, T _A =25°C	—	110	130	μs

4.9 PLL characteristics

Table 25. PLL characteristics

Symbol	Parameter	Conditions	Min	Typ	Max	Unit
f _{PLLIN}	PLL input clock frequency	—	1	—	4	MHz
f _{PLL}	PLL output clock frequency	—	100	—	500	MHz
t _{LOCK}	PLL lock time	VCO freq=100MHz	—	80	168	μs
		VCO freq=500MHz	—	100	300	
I _{DD}	Current consumption on VDD	VCO freq=500MHz	—	750	—	μA
I _{DDA}	Current consumption on VDDA	VCO freq=500MHz	—	1100	—	μA
Jitter _{PLL}	Cycle to cycle Jitter	System clock 120MHz	—	30	—	ps

Table 26. PLL spread spectrum clock generation (SSCG) characteristics

Symbol	Parameter	Conditions	Min	Typ	Max	Unit
F _{MOD}	Modulation frequency	—	—	—	10	KHz
M _{damp}	Peak modulation amplitude	—	—	—	2	%
MODCNT* MODSTEP	—	—	—	—	2 ¹⁵ -1	—

Equation 1: SSCG configuration equation:

$$MODCNT = \text{round}(f_{PLLIN} / 4 / f_{mod})$$

$$MODSTEP = \text{round}(mdamp * PLLN * 2^{14} / (MODCNT * 100))$$

The formula above (Equation 1) is SSCG configuration equation.

4.10 Memory characteristics

Table 27. Flash memory characteristics

Symbol	Parameter	Conditions	Min	Typ	Max	Unit
PE _{CYC}	Number of guaranteed program /erase cycles before failure (Endurance)	T _A =-40°C ~ +85°C	100	—	—	kcycles
t _{RET}	Data retention time	T _A =125°C	20	—	—	years
t _{PROG}	Word programming time	T _A =-40°C ~ +85°C	200	—	400	us
t _{ERASE}	Page erase time	T _A =-40°C ~ +85°C	60	100	450	ms
t _{MERASE}	Mass erase time	T _A =-40°C ~ +85°C	3.2	—	9.6	s

4.11 GPIO characteristics

Table 28. I/O port characteristics

Symbol	Parameter	Conditions	Min	Typ	Max	Unit
V _{IL}	Standard IO Low level input voltage	V _{DD} =2.6V	—	—	1.27	V
		V _{DD} =3.3V	—	—	1.58	
		V _{DD} =3.6V	—	—	1.71	
	High Voltage tolerant IO Low level input voltage	V _{DD} =2.6V	—	—	1.27	V
		V _{DD} =3.3V	—	—	1.58	
		V _{DD} =3.6V	—	—	1.71	
V _{IH}	Standard IO High level input voltage	V _{DD} =2.6V	1.40	—	—	V
		V _{DD} =3.3V	1.71	—	—	
		V _{DD} =3.6V	1.84	—	—	
	High Voltage tolerant IO High level input voltage	V _{DD} =2.6V	1.40	—	—	V
		V _{DD} =3.3V	1.71	—	—	
		V _{DD} =3.6V	1.84	—	—	
V _{OL}	Low level output voltage	V _{DD} =2.6V, I _{IO} =8mA	—	—	0.17	V
		V _{DD} =3.3V, I _{IO} =8mA	—	—	0.16	
		V _{DD} =3.6V, I _{IO} =8mA	—	—	0.16	
		V _{DD} =2.6V, I _{IO} =20mA	—	—	0.46	
		V _{DD} =3.3V, I _{IO} =20mA	—	—	0.40	
		V _{DD} =3.6V, I _{IO} =20mA	—	—	0.40	
V _{OH}	High level output voltage	V _{DD} =2.6V, I _{IO} =8mA	2.39	—	—	V
		V _{DD} =3.3V, I _{IO} =8mA	3.12	—	—	
		V _{DD} =3.6V, I _{IO} =8mA	3.41	—	—	
		V _{DD} =2.6V, I _{IO} =20mA	2.05	—	—	
		V _{DD} =3.3V, I _{IO} =20mA	2.84	—	—	
		V _{DD} =3.6V, I _{IO} =20mA	3.12	—	—	
R _{PU}	Internal pull-up resistor	V _{IN} =V _{SS}	30	40	50	kΩ
R _{PD}	Internal pull-down resistor	V _{IN} =V _{DD}	30	40	50	kΩ

4.12 ADC characteristics

Table 29. ADC characteristics

Symbol	Parameter	Conditions	Min	Typ	Max	Unit
V _{DDA}	Operating voltage	—	2.6	3.3	3.6	V
V _{ADCIN}	ADC input voltage range	—	0	—	V _{REF+}	V
f _{ADC}	ADC clock	—	0.1	—	40	MHz
f _s	Sampling rate	12-bit	0.007	—	2.6	MSPS
		10-bit	0.008	—	3.1	
		8-bit	0.01	—	3.6	
		6-bit	0.011	—	4.4	
V _{IN}	Analog input voltage	16 external;3 internal	0	—	V _{DDA}	V
V _{REF+}	Positive Reference Voltage	—	—	V _{DDA}	—	V
V _{REF-}	Negative Reference Voltage	—	—	0	—	V
R _{AIN}	External input impedance	See <i>Equation 2</i>	—	—	52.1	kΩ
R _{ADC}	Input sampling switch resistance	—	—	—	0.55	kΩ
C _{ADC}	Input sampling capacitance	No pin/pad capacitance included	—	—	5.5	pF
t _{CAL}	Calibration time	f _{ADC} =40MHz	—	3.275	—	μs
t _s	Sampling time	f _{ADC} =40MHz	0.075	—	12	μs
t _{CONV}	Total conversion time (including sampling time)	12-bit	—	15	—	1/ f _{ADC}
		10-bit	—	13	—	
		8-bit	—	11	—	
		6-bit	—	9	—	
t _{SU}	Startup time	—	—	—	1	μs

Equation 2: R_{AIN} max formula
$$R_{AIN} < \frac{T_s}{f_{ADC} \cdot C_{ADC} \cdot \ln(2^{N+2})} - R_{ADC}$$

The formula above (Equation 2) is used to determine the maximum external impedance allowed for an error below 1/4 of LSB. Here N=12 (from 12-bit resolution).

Table 30. ADC R_{AIN} max for f_{ADC}=40MHz

T _s (cycles)	t _s (us)	R _{AIN} max (KΩ)
3	0.075	0.85
15	0.375	6.5
28	0.7	12.6
55	1.375	25.7
84	2.1	38.8
112	2.8	51.9
144	3.6	N/A
480	12	N/A

Note: Guaranteed by design, not tested in production.

Table 31. ADC dynamic accuracy at $f_{ADC} = 30$ MHz

Symbol	Parameter	Test conditions	Min	Typ	Max	Unit
ENOB	Effective number of bits	$f_{ADC}=30\text{MHz}$ $V_{DDA}=V_{REFP}=2.6\text{V}$ Input Frequency=110KHz Temperature=25°C	10.5	10.6	—	bits
SNDR	Signal-to-noise and distortion ratio		65	65.6	—	dB
SNR	Signal-to-noise ratio		65.5	66	—	
THD	Total harmonic distortion		-74	-76	—	

Table 32. ADC dynamic accuracy at $f_{ADC} = 30$ MHz

Symbol	Parameter	Test conditions	Min	Typ	Max	Unit
ENOB	Effective number of bits	$f_{ADC}=30\text{MHz}$ $V_{DDA}=V_{REFP}=3.3\text{V}$ Input Frequency=110KHz Temperature=25°C	10.7	10.8	—	bits
SNDR	Signal-to-noise and distortion ratio		66.2	65.8	—	dB
SNR	Signal-to-noise ratio		66.8	67.4	—	
THD	Total harmonic distortion		-71	-75	—	

Table 33. ADC dynamic accuracy at $f_{ADC} = 36$ MHz

Symbol	Parameter	Test conditions	Min	Typ	Max	Unit
ENOB	Effective number of bits	$f_{ADC}=36\text{MHz}$ $V_{DDA}=V_{REFP}=3.3\text{V}$ Input Frequency=110KHz Temperature=25°C	10.3	10.4	—	bits
SNDR	Signal-to-noise and distortion ratio		63.8	64.4	—	dB
SNR	Signal-to-noise ratio		64.2	65	—	
THD	Total harmonic distortion		-70	-72	—	

Table 34. ADC dynamic accuracy at $f_{ADC} = 40$ MHz

Symbol	Parameter	Test conditions	Min	Typ	Max	Unit
ENOB	Effective number of bits	$f_{ADC}=40\text{MHz}$ $V_{DDA}=V_{REFP}=3.3\text{V}$ Input Frequency=110KHz Temperature=25°C	9.9	10.0	—	bits
SNDR	Signal-to-noise and distortion ratio		61.4	62	—	dB
SNR	Signal-to-noise ratio		62	62.4	—	
THD	Total harmonic distortion		-68	-70	—	

Table 35. ADC static accuracy at $f_{ADC} = 15$ MHz

Symbol	Parameter	Test conditions	Typ	Max	Unit
Offset	Offset error	$f_{ADC}=15\text{MHz}$ $V_{DDA}=V_{REFP}=3.3\text{V}$	±2	±3	LSB
DNL	Differential linearity error		±0.9	±1.2	
INL	Integral linearity error		±1.1	±1.5	

4.13 DAC characteristics

Table 36. DAC characteristics

Symbol	Parameter	Conditions	Min	Typ	Max	Unit
V_{DDA}	Operating voltage	—	2.6	3.3	3.6	V
R_{LOAD}	Resistive load	Resistive load with buffer ON	5	—	—	k Ω
R_o	Impedance output	Impedance output with buffer OFF	—	—	15	k Ω
C_{LOAD}	Capacitive load	Capacitive load with buffer ON	—	—	50	pF
DAC_OUT_{min}	Lower DAC_OUT voltage	Lower DAC_OUT voltage with buffer ON	0.2	—	—	V
		Lower DAC_OUT voltage with buffer OFF	0.5	—	—	mV
DAC_OUT_{max}	Higher DAC_OUT voltage	Higher DAC_OUT voltage with buffer ON	—	—	$V_{DDA} - 0.2$	V
		Higher DAC_OUT voltage with buffer OFF	—	—	$V_{DDA} - 1LSB$	V
I_{DDA}	DC current consumption in quiescent mode with no load	Middle code on the input	—	—	500	μ A
		Worst code on the input	—	—	560	
DNL	Differential non linearity	10-bit configuration	—	—	± 0.5	LSB
		12-bit configuration	—	—	± 2	
INL	Integral non linearity	10-bit configuration	—	—	± 1	LSB
		12-bit configuration	—	—	± 4	
Gain error	Gain error	—	—	± 0.5	—	%
$T_{SETTLING}$	Settling time	$C_{LOAD} \leq 50pF, R_{LOAD} \geq 5k\Omega$	—	0.5	1	μ s
Update rate	Max frequency for a correct DAC_OUT change from code i to $i \pm 1LSB$	$C_{LOAD} \leq 50pF, R_{LOAD} \geq 5k\Omega$	—	—	4	MS/s
T_{WAKEUP}	Wakeup time from off state	$C_{LOAD} \leq 50pF, R_{LOAD} \geq 5k\Omega$	—	1	2	μ s
PSRR	Power supply rejection ratio	No $R_{Load}, C_{LOAD} = 50pF$	—	-90	-75	dB

4.14 SPI characteristics

Table 37. SPI characteristics

Symbol	Parameter	Conditions	Min	Typ	Max	Unit
f _{SCK}	SCK clock frequency	—	—	—	30	MHz
TSl _{K(H)}	SCK clock high time	—	19	—	—	ns
TSl _{K(L)}	SCK clock low time	—	19	—	—	ns
SPI master mode						
t _{V(MO)}	Data output valid time	—	—	—	25	ns
t _{H(MO)}	Data output hold time	—	2	—	—	ns
t _{SU(MI)}	Data input setup time	—	5	—	—	ns
t _{H(MI)}	Data input hold time	—	5	—	—	ns
SPI slave mode						
t _{SU(NSS)}	NSS enable setup time	f _{PCLK} =54MHz	74	—	—	ns
t _{H(NSS)}	NSS enable hold time	f _{PCLK} =54MHz	37	—	—	ns
t _{A(SO)}	Data output access time	f _{PCLK} =54MHz	0	—	55	ns
t _{DIS(SO)}	Data output disable time	—	3	—	10	ns
t _{V(SO)}	Data output valid time	—	—	—	25	ns
t _{H(SO)}	Data output hold time	—	15	—	—	ns
t _{SU(SI)}	Data input setup time	—	5	—	—	ns
t _{H(SI)}	Data input hold time	—	4	—	—	ns

4.15 I2C characteristics

Table 38. I2C characteristics

Symbol	Parameter	Conditions	Standard mode		Fast mode		Unit
			Min	Max	Min	Max	
f _{SCL}	SCL clock frequency	—	0	100	0	400	KHz
TSl _{L(H)}	SCL clock high time	—	4.0	—	0.6	—	ns
TSl _{L(L)}	SCL clock low time	—	4.7	—	1.3	—	ns

4.16 USART characteristics

Table 39. USART characteristics

Symbol	Parameter	Conditions	Min	Typ	Max	Unit
f _{SCK}	SCK clock frequency	—	—	—	36	MHz
TSl _{K(H)}	SCK clock high time	—	13	—	—	ns
TSl _{K(L)}	SCK clock low time	—	13	—	—	ns

5 Package information

5.1 LQFP package outline dimensions

Figure 9. LQFP package outline

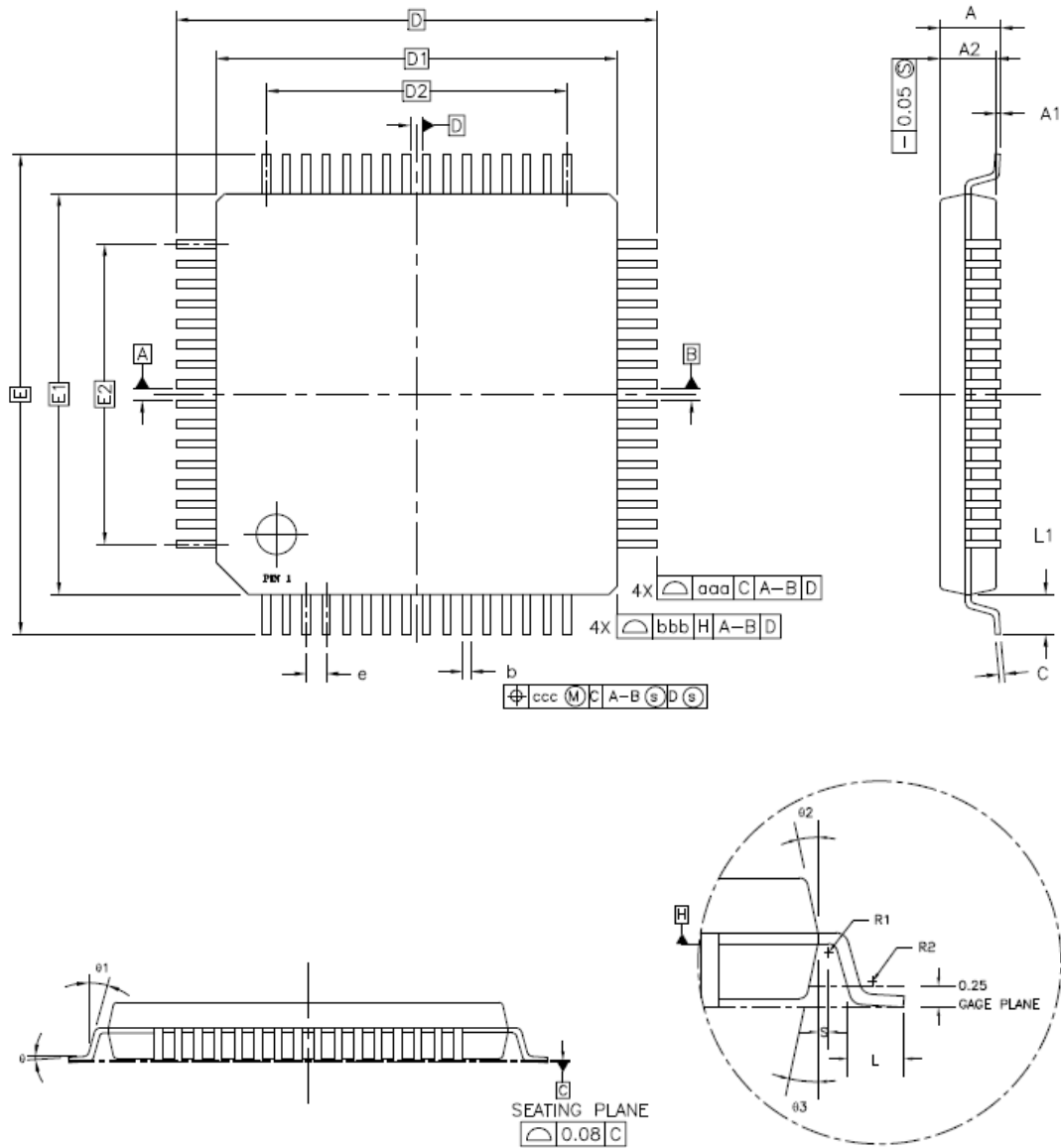

Table 40. LQFP package dimensions

Symbol	LQFP64			LQFP100			LQFP144		
	Min	Typ	Max	Min	Typ	Max	Min	Typ	Max
A	-	-	1.60	-	-	1.60	-	-	1.60
A1	0.05	-	0.15	0.05	-	0.15	0.05	-	0.15
A2	1.35	1.40	1.45	1.35	1.40	1.45	1.35	1.40	1.45
D	-	12.00	-	-	16.00	-	-	22.00	-
D1	-	10.00	-	-	14.00	-	-	20.00	-
E	-	12.00	-	-	16.00	-	-	22.00	-
E1	-	10.00	-	-	14.00	-	-	20.00	-
R1	0.08	-	-	0.08	-	-	0.08	-	-
R2	0.08	-	0.20	0.08	-	0.20	0.08	-	0.20
θ	0°	3.5°	7°	0°	3.5°	7°	0°	3.5°	7°
θ_1	0°	-	-	0°	-	-	0°	-	-
θ_2	11°	12°	13°	11°	12°	13°	11°	12°	13°
θ_3	11°	12°	13°	11°	12°	13°	11°	12°	13°
c	0.09	-	0.20	0.09	-	0.20	0.09	-	0.20
L	0.45	0.60	0.75	0.45	0.60	0.75	0.45	0.60	0.75
L1	-	1.00	-	-	1.00	-	-	1.00	-
S	0.20	-	-	0.20	-	-	0.20	-	-
b	0.17	0.20	0.27	0.17	0.20	0.27	0.17	0.20	0.27
e	-	0.50	-	-	0.50	-	-	0.50	-
D2	-	7.50	-	-	12.00	-	-	17.50	-
E2	-	7.50	-	-	12.00	-	-	17.50	-
aaa	0.20			0.20			0.20		
bbb	0.20			0.20			0.20		
ccc	0.08			0.08			0.08		

(Original dimensions are in millimeters)

5.2 BGA package outline dimensions

Figure 10. BGA package outline

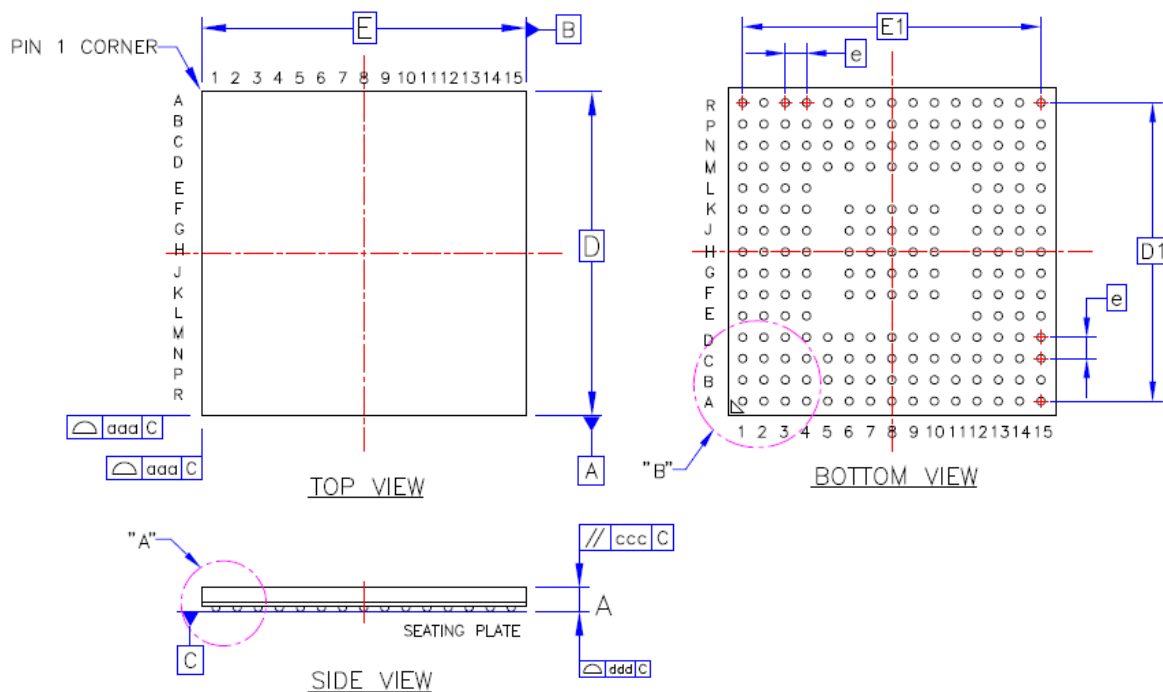

Table 41. BGA package dimensions

Symbol	BGA100			BGA176+25 (201 Ball)		
	Min	Typ	Max	Min	Typ	Max
A	-	0.74	0.84	-	0.74	0.84
A1	0.11	0.16	0.21	0.11	0.16	0.21
A2	-	0.45	-	-	0.45	-
A3	0.10	0.13	0.16	0.10	0.13	0.16
D	6.90	7.00	7.10	9.90	10.00	10.10
E	6.90	7.00	7.10	9.90	10.00	10.10
e	-	0.50	-	-	0.65	-
b	0.20	0.25	0.30	0.20	0.25	0.30
D1	-	5.50	-	-	9.10	-
E1	-	5.50	-	-	9.10	-
aaa	0.10			0.10		
bbb	-			-		
ccc	0.10			0.10		
ddd	0.08			0.08		
eee	0.15			0.15		
fff	0.05			0.05		

(Original dimensions are in millimeters)

6 Ordering information

Table 42. Part ordering code for GD32F407xx devices

Ordering code	Flash (KB)	Package	Package type	Temperature operating range
GD32F407RET6	512	LQFP64	Green	Industrial -40°C to +85°C
GD32F407RGT6	1024	LQFP64	Green	Industrial -40°C to +85°C
GD32F407RKT6	3072	LQFP64	Green	Industrial -40°C to +85°C
GD32F407VET6	512	LQFP100	Green	Industrial -40°C to +85°C
GD32F407VGT6	1024	LQFP100	Green	Industrial -40°C to +85°C
GD32F407VKT6	3072	LQFP100	Green	Industrial -40°C to +85°C
GD32F407VEH6	512	BGA100	Green	Industrial -40°C to +85°C
GD32F407VGH6	1024	BGA100	Green	Industrial -40°C to +85°C
GD32F407VKH6	3072	BGA100	Green	Industrial -40°C to +85°C
GD32F407ZET6	512	LQFP144	Green	Industrial -40°C to +85°C
GD32F407ZGT6	1024	LQFP144	Green	Industrial -40°C to +85°C
GD32F407ZKT6	3072	LQFP144	Green	Industrial -40°C to +85°C
GD32F407IEH6	512	BGA176	Green	Industrial -40°C to +85°C
GD32F407IGH6	1024	BGA176	Green	Industrial -40°C to +85°C
GD32F407IKH6	3072	BGA176	Green	Industrial -40°C to +85°C

7 Revision history

Table 43. Revision history

Revision No.	Description	Date
1.0	Initial Release	Oct. 25, 2016